



1U EDR SB7XX0 100Gb/s InfiniBand Switch Systems and IB Router Hardware User Manual

SB7700, SB7790, SB7800, SB7890, SB7780

Table of Contents

Introduction.....	7
Speed and Switching Capabilities	8
Management Interfaces and FRUs	8
Features	9
Certifications	9
Installation.....	10
System Installation and Initialization	10
Safety Warnings	10
Air Flow.....	11
Package Contents	12
19" Rack Mounting Options	12
Static Rail Kit	12
Removing the System from the Rack.....	16
Telescopic Rail Kit	16
Removing the System from the Rack.....	19
Cable Installation	20
Initial Power On	21
System Bring-Up of Managed Systems	22
Configuring Network Attributes.....	22
Remote Connection.....	25
FRU Replacements	26
Power Supply	26
Fans	27
Software Management	28
InfiniBand Subnet Manager	28
Upgrading Software (on Managed Systems).....	28
Updating Firmware on Externally Managed Systems	29
Updating Firmware In-band (Typical).....	29
Interfaces	31
Data Interfaces.....	31
Speed	31
I2C/RS232 (Console).....	31

Management	32
USB	32
Reset Button	32
LEDs	33
LED Notifications.....	33
System Status LED	34
Fan Status LED.....	34
Power Supply Status LEDs.....	35
Unit Identification LED	37
Bad Port LED	37
Port LEDs	37
Inventory Pull-out Tab.....	38
Troubleshooting	39
Specifications.....	41
Appendixes.....	43
Accessory and Replacement Parts.....	43
Thermal Threshold Definitions.....	43
Interface Specifications.....	44
QSFP28 Pin Description	44
RJ-45 CONSOLE and I ² C Interface	46
RJ45 to DB9 Harness Pinout	46
Disassembly and Disposal	47
Disassembly Procedure	47
Disposal.....	47
Switch Safety Warnings (Multiple Languages)	48
Switch Safety Warnings (English)	48
Nordic Countries Notices	53
安裝安全性警告 (Simplified Chinese)	53
安裝安全性警告 (Chinese)	59
Avertissements de sécurité pour l'installation (French).....	65
Installation Sicherheitshinweise (German).....	69
Advertencias de seguridad de instalación (Spanish).....	72
Предупреждения по технике безопасности при установке (Russian).....	76
Avertismente privind siguranța la instalare (Romanian)	80

Sigurnosna upozorenja za instaliranje (Croatian).....	83
Avvertenze di sicurezza per l'installazione (Italian)	87
Montaj Güvenlik Uyarıları (Turkish)	90
Japan VCCI Statement	93
(Hebrew) הוראות בטיחות בהתקנה.....	93
Document Revision History	97

Relevant for Models: SB7700, SB7790, SB7800, SB7890, SB7780 and SB7880.

About this Manual

This manual describes the installation and basic use of the NVIDIA InfiniBand EDR 1U switches.

Ordering Information

The following table lists ordering information for the available systems.

Please pay attention to the airflow direction when ordering your system. For more details, see [Air Flow](#).

System Model	OPN	Legacy OPN	Description
SB7700	920-9B010-00FE-0M2	MSB7700-ES2F	Switch-IB™ based EDR InfiniBand 1U Switch, 36 QSFP28 ports, 2 Power Supplies (AC), x86 dual core, standard depth, P2C airflow, Rail Kit
	920-9B010-00RE-0M0	MSB7700-ES2R	Switch-IB™ based EDR InfiniBand 1U Switch, 36 QSFP28 ports, 2 Power Supplies (AC), x86 dual core, standard depth, C2P airflow, Rail Kit
	920-9B010-00FE-0M0	MSB7700-EB2F	Switch-IB™ based EDR InfiniBand 1U Switch, 36 QSFP28 ports, 2 Power Supplies (AC), x86 dual core, short depth, P2C airflow, Rail Kit
SB7790	920-9B010-00FE-0D1	MSB7790-ES2F	Switch-IB™ based EDR InfiniBand 1U Switch, 36 QSFP28 ports, 2 Power Supplies (AC), unmanaged, standard depth, P2C airflow, Rail Kit
	920-9B010-00FE-0D0	MSB7790-EB2F	Switch-IB™ based EDR InfiniBand 1U Switch, 36 QSFP28 ports, 2 Power Supplies (AC), unmanaged, Short depth, P2C airflow, Rail Kit
	920-9B010-00RE-0D0	MSB7790-ES2R	Switch-IB™ based EDR InfiniBand 1U Switch, 36 QSFP28 ports, 2 Power Supplies (AC), unmanaged, standard depth, C2P airflow, Rail Kit
SB7800	920-9B110-00FE-0M3	MSB7800-ES2F	Switch-IB™ 2 based EDR InfiniBand 1U Switch, 36 QSFP28 ports, 2 Power Supplies (AC), x86 dual core, standard depth, P2C airflow, Rail Kit
	920-9B110-00RE-0M0	MSB7800-ES2R	Switch-IB™ 2 based EDR InfiniBand 1U Switch, 36 QSFP28 ports, 2 Power Supplies (AC), x86 dual core, standard depth, C2P airflow, Rail Kit
SB7890	920-9B110-00FE-0D0	MSB7890-ES2F	Switch-IB™ 2 based EDR InfiniBand 1U Switch, 36 QSFP28 ports, 2 Power Supplies (AC), unmanaged, standard depth, P2C airflow, Rail Kit
	920-9B110-00RE-0D0	MSB7890-ES2R	Switch-IB™ 2 based EDR InfiniBand 1U Switch, 36 QSFP28 ports, 2 Power Supplies (AC), unmanaged, standard depth, C2P airflow, Rail Kit
SB7780	920-9B010-00FE-0M1	MSB7780-ES2F	Switch-IB™-based 36-port QSFP28 EDR 1U Managed InfiniBand router system with non-blocking switching capacity of 7Tb/s. 2PS, Standard depth, P2C airflow
SB7880	920-9B110-00FE-0M1	MSB7880-ES2F	Switch-IB 2 based 36-port QSFP28 EDR 1U router, 2 Power Supplies (AC), x86 dual core, standard depth, P2C* airflow, Rail Kit
	920-9B110-00RE-0M1	MSB7880-ES2R	Switch-IB 2 based 36-port QSFP28 EDR 1U router, 2 Power Supplies (AC), x86 dual core, standard depth, C2P* airflow, Rail Kit

Intended Audience

This manual is intended for IT managers and system administrators.

Related Documentation

Document	Description
<i>InfiniBand Architecture Specification</i> Volume 1, Release 1.2.1, and Volume 2, Release 1.3	The InfiniBand Architecture Specification provided by IBTA.
<i>MLNX-OS® User Manual</i>	This document contains information regarding the configuration and management of the MLNX-OS® software. See https://docs.nvidia.com/networking/category/mlnxos .
Hands-on workshops	https://academy.nvidia.com/en/infiniband-customized-training/
On-site/remote services	For any tailor-made service, contact: nbu-services-sales@nvidia.com .

Revision History

A list of the changes made to this document are provided in [Document Revision History](#).

Introduction

Mellanox SB77X0/SB78X0 switch systems provide the highest performing fabric solution in a 1U form factor by delivering up to 7.2Tb/s of non-blocking bandwidth with sub 90ns port-to-port latency. These systems are the industry's most cost-effective building blocks for embedded systems and storage with a need for low port density systems. Whether looking at price-to-performance or energy-to-performance, these systems offer superior performance, power and space, reducing capital and operating expenses and providing the best return-on-investment.

Powerful servers combined with high-performance storage and applications that use increasingly complex computations are causing data bandwidth requirements to spiral upward. As servers are deployed with next generation processors, High-Performance Computing (HPC) environments and Enterprise Data Centers (EDC) need every last bit of bandwidth delivered with Mellanox's EDR InfiniBand systems.

Built with Mellanox's latest SwitchIB™ InfiniBand EDR 100Gb/s switch device, these standalone systems are an ideal choice for top-of-rack leaf connectivity or for building small to extremely large sized clusters. These systems enable efficient computing with features such as static routing, adaptive routing, and advanced congestion management. These features ensure the maximum effective fabric bandwidth by eliminating congestion.

The SB7700/SB7800, dual-core x86 CPU, comes with an onboard subnet manager, enabling simple, out-of-the-box fabric bring-up for up to 2048 nodes.

SB7700/SB7800 switches run the same MLNX-OS® software package as Mellanox FDR products to deliver complete chassis management of the firmware, power supplies, fans and ports.

Mellanox's edge systems can also be coupled with Mellanox's Unified Fabric Manager (UFM®) software for managing scale-out InfiniBand computing environments. UFM enables data center operators to efficiently provision, monitor and operate the modern data center fabric. UFM boosts application performance and ensures that the fabric is up and running at all times.

InfiniBand systems come as internally or externally managed. Internally managed systems include a CPU that runs the management software (MLNX-OS®) and management ports, which are used to transfer management traffic into the system. Externally managed systems come without the CPU and management ports, and are managed using firmware tools.

The SB7780 InfiniBand router is based on the SwitchIB™ switch ASIC, and offers fully flexible 36 EDR 100Gb/s ports, which can be split among six different subnets. The InfiniBand router brings two major enhancements to the Mellanox switch portfolio:

- Increases resiliency by segregating the data center's network into several subnets, with each subnet running its own subnet manager, effectively isolating each subnet from the others' availability or instability.
- Enables scaling of the fabric up to a virtually unlimited number of nodes.

SB77X0/SB78X0 Front Side View

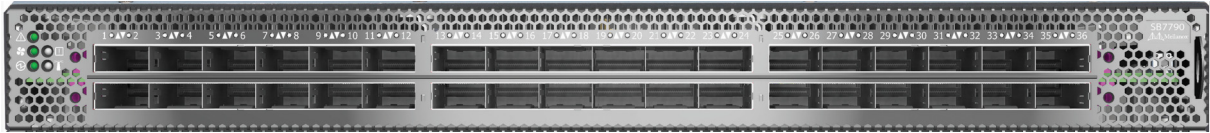

SB7700/SB7780/SB7800* Rear Side View



SB7790/SB7890 Rear Side View



*The SB7800 models include one MGT port labeled .

Speed and Switching Capabilities

The table below describes maximum throughput and interface speed per system model.

System Model	EDR 100Gb/s QSFP28 Interfaces	Max Throughput
SB7700	36	7.2Tb/s
SB7790	36	7.2Tb/s
SB7800	36	7.2Tb/s
SB7890	36	7.2Tb/s
SB7780	36	7.2Tb/s

Management Interfaces and FRUs

The table below lists the various management interfaces and available replacement parts per system model.

System Model	USB	MGT	I ² C*	Console*	Replaceable PSU	Replaceable Fan
SB7700	Rear	Rear (2 ports)	Rear	Rear	Yes	Yes
SB7790	N/A	N/A	Rear	N/A	Yes	Yes
SB7800	Rear	Rear (1 port)	Rear	Rear	Yes	Yes
SB7890	N/A	N/A	Rear	N/A	Yes	Yes
SB7780	Rear	Rear (2 ports)	Rear	Rear	Yes	Yes

*The same connector is used for the I²C and the console interfaces.

Features

For a full feature list, please refer to the systems' product briefs at www.mellanox.com.

Certifications

The list of certifications (such as EMC, Safety and others) per system for different regions of the world is located on the Mellanox website at http://www.mellanox.com/page/environmental_compliance.

Installation

System Installation and Initialization

Installation and initialization of the system require attention to the normal mechanical, power, and thermal precautions for rack-mounted equipment.



The rack mounting holes conform to the EIA-310 standard for 19-inch racks. Take precautions to guarantee proper ventilation in order to maintain good airflow at ambient temperature.



This unit is intended for installation in a restricted access location. A restricted access area can be accessed only through the use of a special tool, lock and key, or other means of security.



Unless otherwise specified, NVIDIA products are designed to work in an environmentally controlled data center with low levels of gaseous and dust (particulate) contamination.

The operation environment should meet severity level G1 as per ISA 71.04 for gaseous contamination and ISO 14644-1 class 8 for cleanliness level.

The installation procedure for the system involves the following phases:

Step	Procedure	See
1	Follow the safety warnings	English Safety Warnings
2	Pay attention to the air flow consideration within the system and rack	Air Flow
3	Make sure that none of the package contents is missing or damaged	Package Contents
4	Mount the system into a rack enclosure	19" Systems Mounting Options
5	Power on the system	Initial Power On
6	Perform system bring-up	System Bring-Up of Managed Systems
7	[Optional] FRU replacements	FRU Replacements

Safety Warnings

Prior to the installation, please review the [Safety Warnings](#). Note that some warnings may not apply to all models.

Air Flow

NVIDIA systems are offered with two air flow patterns:

- Power (rear) side inlet to connector side outlet - marked with blue power supplies/fans FRUs' handles.

Air Flow Direction Marking - Power Side Inlet to Connector Side Outlet



- Connector (front) side inlet to power side outlet - marked with red power supplies/fans FRUs' handles.

Air Flow Direction Marking - Connector Side Inlet to Power Side Outlet



All servers and systems in the same rack should be planned with the same airflow direction.

All FRU components need to have the same air flow direction. A mismatch in the air flow will affect the heat dissipation.

The table below provides an air flow color legend and respective OPN designation.

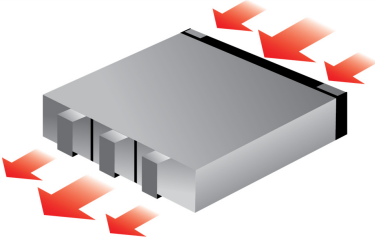
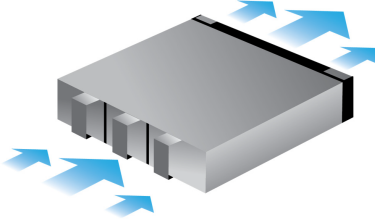
Direction	Description and OPN Designation
	<p>Connector side inlet to power side outlet. Red latches are placed on the power inlet side. Ending with "R".</p>
	<p>Power side inlet to connector side outlet. Blue latches are placed on the power inlet side. Ending with "F".</p>

Package Contents

Before installing your new system, unpack it and check against the parts list below that all the parts have been sent. Check the parts for visible damage that may have occurred during shipping.

The SB77X0/SB78X0 package content is as follows:

- 1 x System
- 1 x Rail kit
- 2 x Power cables - Type C13-C14
- 1 x Harness: HAR000028 - Harness RS232 2M cable - DB9 to RJ-45 (in SB7X00 models only)
- 2 x Cable retainers
- *Quick Start Guide*



If anything is damaged or missing, contact your sales representative at Networking-support@nvidia.com.

19" Rack Mounting Options

- By default, the system is sold with the static rail kit described in [Static Rail Kit](#).
- A telescopic rail-kit can be purchased separately. For the telescopic rail kit installation instructions, see [Telescopic Rail Kit](#).

Static Rail Kit

OPN	Legacy Kit OPN	Rack Size and Rack Depth Range
930-9BRKT-00JC-000	MTEF-KIT-A	Short (17"-24") or Standard (24"-34")

The following parts are included in the static rail kit (see figure below):

- 2x Rack mount rails (A)
- 2x Rack mount brackets (B)
- 2x Rack mount blades (C)
- 8x M6 Standard cage nuts and 8x M6 Standard pan-head Phillips screws (D)
- 4x Phillips100 DEG F.H TYPE-I ST.ST 6-32 X 1/4 screws with a round patch (E)

Rack Rail Kit Parts

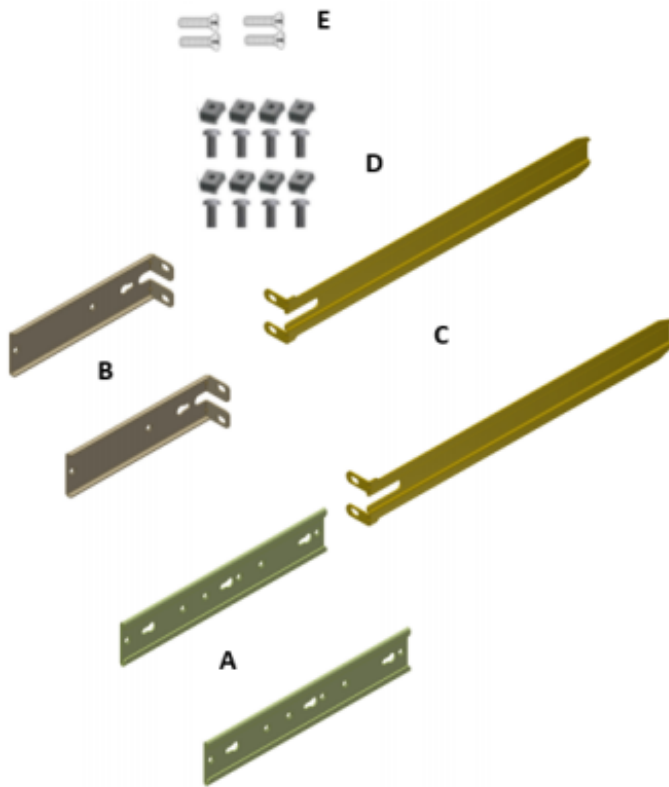

Prerequisites:

Before mounting the system to the rack, select the way you wish to place the system. Pay attention to the airflow within the rack cooling, connector and cabling options.

While planning how to place the system, consider the two installation options shown in the figure below, and review the following points:

- Make sure the system air flow is compatible with your installation selection. It is important to keep the airflow within the rack in the same direction.
- Note that the part of the system to which you choose to attach the rails (the front panel direction, as demonstrated in Option 1 or the FRUs direction, as demonstrated in Option 2) will determine the system's adjustable side. The system's part to which the brackets are attached will be adjacent to the cabinet.
- The FRU side is extractable. Mounting the rack brackets inverted to the FRU side (Option 2) will allow you to slide the FRUs, in and out.

Installation Option 1 & Option 2

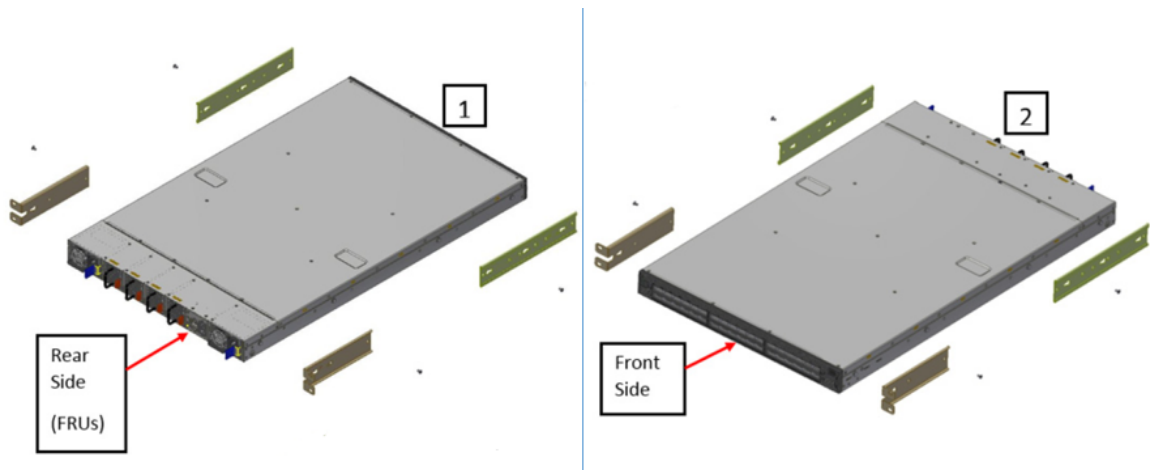

To mount the system into the rack:

⚠ At least two people are required to safely mount the system in the rack.

1. Attach the left and right rack mount rails (A) to the switch, by gently pushing the switch chassis' pins through the slider key holes, until locking occurs.
2. Secure the chassis in the rails by screwing 2 flat head Phillips screws (E) in the designated points with a torque of 1.5 ± 0.2 Nm.

Attaching the Rails to the Chassis

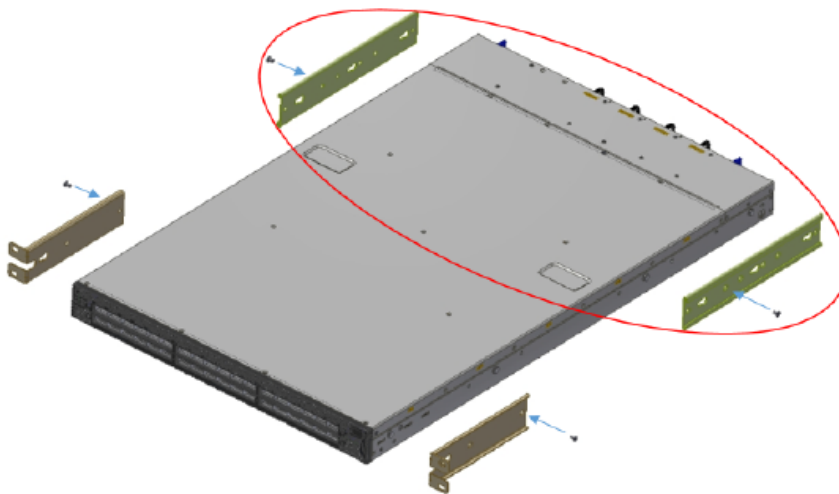

3. Attach the left and right rack mount brackets (B) to the switch, by gently pushing the switch chassis' pins through the slider key holes, until locking occurs. Secure the system in the brackets by screwing the remaining 2 flat head Phillips screws (E) in the designated points with a torque of 1.5 ± 0.2 Nm.

Attaching the Brackets to the Chassis

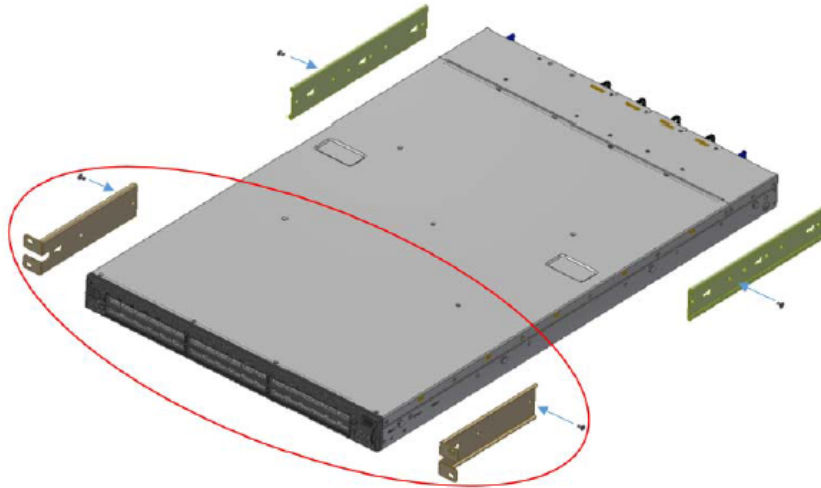

4. Install 8 cage nuts in the desired slots of the rack: 4 cage nuts in the non-extractable side (in the top and bottom holes only) and 4 cage nuts in the extractable side.

Installing the Cage Nuts



⚠ While each rack U (unit) consists of three holes, the cage nut should be installed vertically with its ears engaging the top and bottom holes only.

While your installation partner is supporting the system's weight, perform the following steps:

5. Mount the system into the rack enclosure, and attach the brackets installed on the system to the rack's posts. Secure the brackets to the rack's posts by inserting four M6 screws in the designated cage nuts, as described in the figure below. Do not tighten the screws yet.

Attaching the Brackets to the Rack

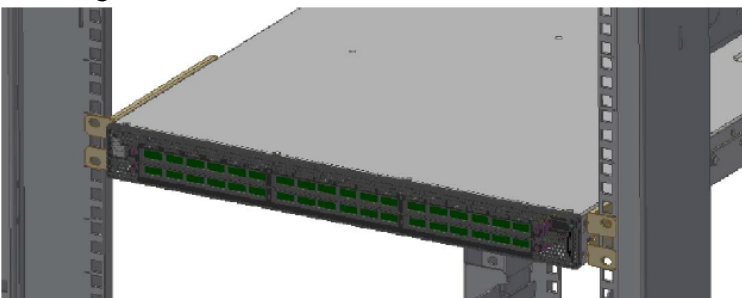

6. Slide the two blades into the left and right rails, and adjust them to fit your rack's depth. Use four M6 screws (D) to fix the blades into the rack. Do not tighten the screws yet.

Sliding the Blades in the Rails

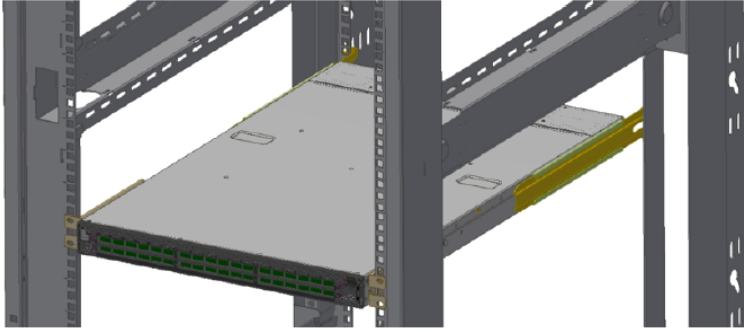

7. Secure the system in the rack by tightening the 8 screws inserted in Step 5 and Step 6 with a torque of 4.5 ± 0.5 Nm.

Removing the System from the Rack

To remove a unit from the rack:

1. Turn off the system and disconnect it from peripherals and from the electrical outlet.
While your installation partner is supporting the system's weight:
2. Loosen the screws attaching the brackets to the rack. Do not remove them yet.
3. Loosen the screws attaching the blades to the rack, and pull the blades towards you, while your partner is holding the system.
4. Extract the loosened screws from Step 2 and dismount the system from the rack.
5. Remove the rails and brackets from the chassis by unscrewing 8 screws.

Telescopic Rail Kit

⚠ The telescopic rail kit is not included in the system's package, and can be purchased separately.

There are two installation kit options:

- Standard depth systems should be mounted using the standard rail kit.
- Short depth systems can be mounted using either of the rail kits.

Kit OPN	Legacy Kit OPN	Rack Size and Rack Depth Range
930-9BRKT-00JD-000	MTEF-KIT-B	Short: 17"-24"
930-9NRKT-00JT-000	MTEF-KIT-S	Standard (long): 24"-38"

The following parts are included in the rail kit package (see figure below):

- 1x Right inner rail (A)
- 1x Left inner rail (B)
- 2x Outer rails (C)
- 2x Outer rails (D)
- 10x M6 Standard cage nuts^{1 2} and 10x M6 Standard pan-head Phillips screws¹ (E)
- 2x Phillips100 DEG F.H TYPE-I ST.ST 6-32 X 1/4 screw with around patch (F)

¹ Other threads are available by special order: M5, 10-32, 12-24. ² G-type cage-nut is available by special order.

Rack Rail Kit Parts

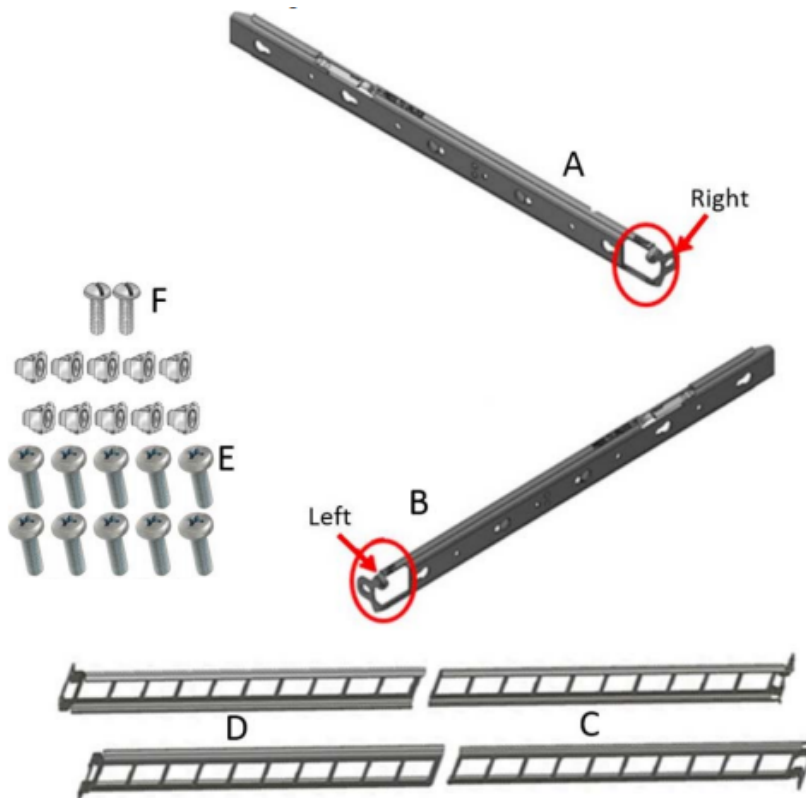

Prerequisites

⚠ The rails must be separated prior to the installation procedure.

To separate the rails:

1. Extend the rail assembly by pulling the extension outwards (D).
2. Extract rail A from rail C by pushing it outside from the rear part of the assembly. To allow complete separation of rail A from rail C, press the quick-release latch.

Rails Separation

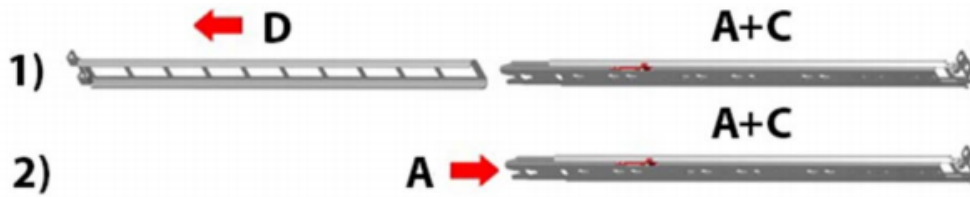

Before mounting the system to the rack, select the way you wish to place the system. Pay attention to the airflow within the rack cooling, connector and cabling options.

While planning how to place the system, review the following points:

- Make sure the system air flow is compatible with your installation selection. It is important to keep the airflow within the rack in the same direction.
- In case there are cables that cannot bend within the rack, or in case more space is needed for cable bending radius, it is possible to recess the connector side or the FRU side by 3” or 4” (7.62 or 10.16cm) by optional placement of the system’s rails.
- The FRU side is extractable. Mounting the sliding rail inverted to the system will allow you to slide the FRU side of the system, in and out.

To mount the system into the rack:

1. Insert 10 cage nuts into the desired slots of the rack: 4 cage nuts in the non-extractable side and 6 cage nuts in the extractable side.

Installing the Cage Nuts



2. Mount both of the outer rails (C+D) into the rack (as illustrated below), and use 8 standard pan-head screws (E) to fix them to the rack. Do not tighten the screws yet.

Mounting the Outer Rails into the Rack



3. If cable accommodation is required, route the power cable and/or Eth cable through either of the outer rails. Mounting the Outer Rails into the Rack
4. Attach left and right inner rails (A+B) to the switch sides, by gently pushing the switch chassis’ pins through the slider key holes, until locking occurs.

Attaching the Inner Rails

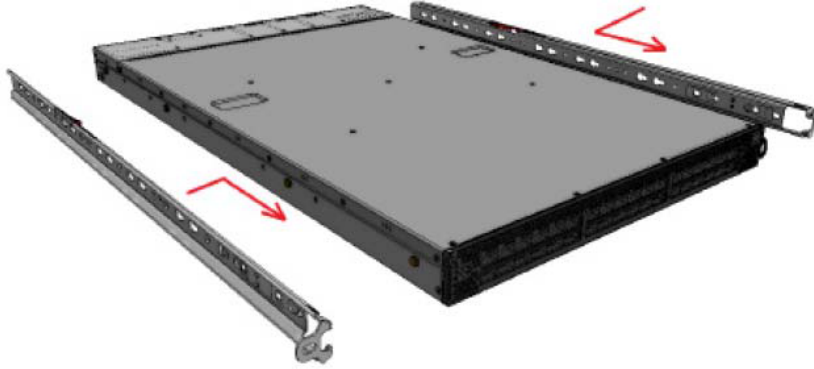

5. Secure the chassis in the inner rails by screwing the 2 flat head Phillips screws (F) in the designated points with a torque of 1.5 ± 0.2 Nm.
Securing the Chassis in the Inner Rails



6. Slide the switch into the rack by carefully pushing the inner rails into the outer rails installed on the rack.
Sliding the Switch into the Rack

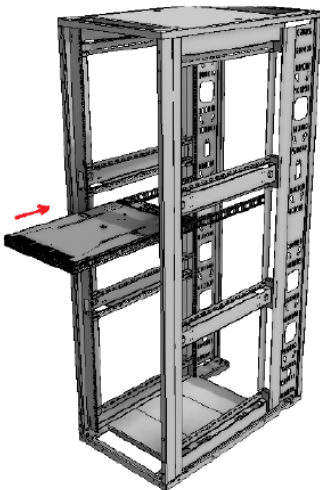

7. When fully inserted, fix the switch by closing the remaining 2 screws in the middle and tightening the 8 screws inserted in Step 2 with a torque of 4.5 ± 0.5 Nm.

Removing the System from the Rack

To remove a unit from the rack:

1. Turn off the system and disconnect it from peripherals and from the electrical outlet.
2. Unscrew the two M6 screws securing the front of the inner rails' ears to the outer rails and to the rack.
3. Pull the unit out until braking is felt. For safety purposes, the locking mechanism will not allow a complete removal of the unit at this stage.

Pulling the Unit Outwards

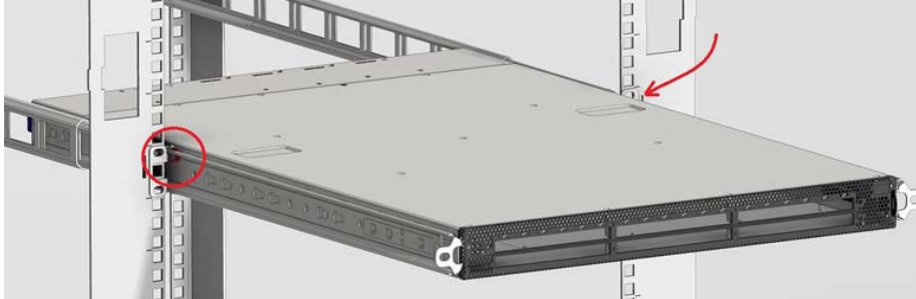

4. Press on the locking spring (appears in red in the figure below) on both sides simultaneously, and continue pulling the unit towards you until it is fully removed.

Locking Mechanism



Cable Installation

All cables can be inserted or removed with the unit powered on.

To insert a cable, press the connector into the port receptacle until the connector is firmly seated. The LED indicator, corresponding to each data port, will light when the physical connection is established. When a logical connection is made, the relevant port LED will turn on.

To remove a cable, disengage the locks and slowly pull the connector away from the port receptacle. The LED indicator for that port will turn off when the cable is unseated.

For full cabling guidelines, please refer to the [Mellanox Cable Management Guidelines and FAQ](#).

For more information about port LEDs, refer to [Port LEDs](#).

- ⚠ Do not force the cable into the cage with more than 40 newtons / 9.0 pounds / 4kg force. Greater insertion force may cause damage to the cable or to the cage.

Cable Orientation

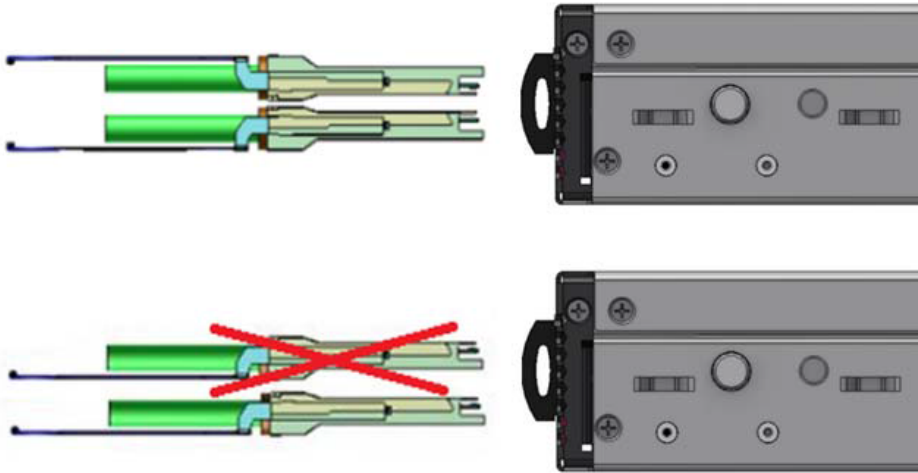

Initial Power On

Each system's input voltage is specified in the [Specifications](#) chapter.

The power cords should be standard 3-wire AC power cords including a safety ground and rated for 15A or higher.

- ⚠ The system platform will automatically power on when AC power is applied. There is no power system. Check all boards, power supplies, and fan tray modules for proper insertion before plugging in a power cable.

1. Plug in the first power cable.
2. Plug in the second power cable.
3. Wait for the System Status LED to turn green.

- ⚠ It may take up to five minutes to turn on the system. If the System Status LED shows amber after five minutes, unplug the system and call your NVIDIA representative for assistance.

4. Check the System Status LEDs and confirm that all of the LEDs show status lights consistent with normal operation (initially flashing, and then moving to a steady color) as shown in figures below. For more information, refer to [LED Notifications](#).

System Status LEDs 5 Minutes After Power On



- ⚠ After inserting a power cable and confirming the green System Status LED light is on, make sure that the Fan Status LED shows green. If the Fan Status LED is not green, unplug the power connection and check that the fan module is inserted properly and that the mating

connector of the fan unit is free of any dirt and/or obstacles. If no obstacles were found and the problem persists, call your NVIDIA representative for assistance.

Two Power Inlets - Electric Caution Notifications:

- ❗ Risk of electric shock and energy hazard. The two power supply units are independent. Disconnect all power supplies to ensure a powered down state inside of the switch platform.
- ACHTUNG Gefahr des elektrischen Schocks. Entfernen des Netzsteckers eines Netzteils spannungsfrei. Um alle Einheiten spannungsfrei zu machen sind die Netzstecker aller Netzteile zu entfernen.
- ATTENTION Risque de choc et de danger électrique. Le débranchement d'une seule alimentation stabilisée ne débranch uniquement qu'un module "Alimentation Stabilisée". Pour isoler complètement le module en cause, il faut débrancher toutes les alimentations stabilisées.
- 電擊與能源危害的危險。所有 PSU 均各自獨立。將所有電源供應器斷電，確保交換器平台內部在電源關閉狀態。

System Bring-Up of Managed Systems

- ❗ The bring-up procedures described in this section do not apply to unmanaged/externally managed systems. Such systems are ready for operation after power-on.

In order to query the system, perform firmware upgrade or other firmware operation. Refer to the latest NVIDIA Firmware tools (MFT) located at <https://network.nvidia.com/support/firmware/firmware-downloads/>.

In order to obtain the firmware version of the externally managed system:

1. Run the following command from a host:

```
# flint -d <device> q
```

2. Compare the results of this command with the latest version for your system posted on <https://network.nvidia.com/support/firmware/firmware-downloads/>.
3. If the current version is not the latest version, follow the directions in the *MFT User Manual* to burn the new firmware.

Configuring Network Attributes

The procedures described in this chapter assume that you have already installed and powered on the system according to the instructions in this document. Since the system comes with a pre-configured DHCP, you may find the explanation in [Disable Dynamic Host Configuration Protocol \(DHCP\)](#). In case a manual configuration is required, please refer to the instructions in [Manual Host Configuration](#).

Disable Dynamic Host Configuration Protocol (DHCP)

DHCP is used for automatic retrieval of management IP addresses.

If a user connects through SSH, runs the wizard and turns off DHCP, the connection is immediately terminated, as the management interface loses its IP address. In such a case, the serial connection should be used.





```
<localhost># ssh admin@<ip-address>

Mellanox MLNX-OS Switch Management
Password:
Mellanox Switch
Mellanox configuration wizard
Do you want to use the wizard for initial configuration? yes
Step 1: Hostname? [my-switch]
Step 2: Use DHCP on mgmt0 interface? [yes] no
<localhost>#
```

Manual Host Configuration

To perform initial configuration of the system:

Step 1. Connect a host PC to the Console RJ45 () port of the system, using the supplied harness cable (DB9 to RJ45). Make sure to connect to the Console RJ45 port and not to the (Ethernet) MGT () port.

Step 2. Configure a serial terminal program (for example, HyperTerminal, minicom, or Tera Term) on your host PC with the settings described in the table below. Once you perform that, you should get the CLI prompt of the system.

Serial Terminal Program Configuration

Parameter	Setting
Baud Rate	115200
Data bits	8
Stop bits	1
Parity	None
Flow Control	None

Step 3. Login as admin and use admin as password. On the first login, the MLNX-OS configuration wizard will start.

Step 4. To configure network attributes and other initial parameters to the system, follow the configuration wizard as shown in the Configuration Wizard Session table below.

Configuration Wizard Session

Wizard Session Display	Comments
Mellanox configuration wizard Do you want to use the wizard for initial configuration? yes	You must perform this configuration the first time you operate the system or after resetting the system. Type 'y' and then press <Enter>.
Step 1: Hostname? [switch]	If you wish to accept the default hostname, press <Enter>. Otherwise, type a different hostname and press <Enter>.
Step 2: Use DHCP on mgmt0 interface? [no] yes	Perform this step to obtain an IP address for the system. (mgmt0 is the management port of the system). If you wish the DHCP server to assign the IP address, type 'yes' and press <Enter>. If you type 'no' (no DHCP), then you will be asked whether you wish to use the 'zeroconf' configuration or not. If you enter 'no' (no Zeroconf), you must enter a static IP, and the session will continue.
Step 3: Enable IPv6? [yes]	The management interface will be able to use IPv6 addresses. If you enter "no" (no IPv6), you will automatically be referred to Step 6.
Step 4: Enable IPv6 auto-config (SLAAC) on mgmt0 interface? [no]	This turns on auto-configuration of the IPv6 addresses. This is unsuitable for DHCPv6.
Step 5: Enable DHCPv6 on mgmt0 interface? [no]	To enable DHCPv6 on the MGMT0 interface.
Step 6: Admin password (Press <Enter> to leave unchanged)? <new_password> Step 6: Confirm admin password? <new_password>	To avoid illegal access to the machine, please type a password and then press <Enter>. Then confirm the password by re-entering it. Note that password characters are not printed.
You have entered the following information: <A summary of the configuration is now displayed.> To change an answer, enter the step number to return to or hit <enter> to save changes and exit. Choice: <Enter> Configuration changes saved.	The wizard displays a summary of your choices and then asks you to confirm the choices or to re-edit them. Either press <Enter> to save changes and exit, or enter the configuration step number that you wish to return to. <i>Note: To re-run the configuration wizard, run the command "configuration jump-start" in Config mode.</i>

The table below shows an example of static IP configuration for mgmt0 interface.

Configuration Wizard Session - Static IP Configuration

NVIDIA configuration wizard

```

Do you want to use the wizard for initial configuration? yes

Step 1: Hostname? []
Step 2: Use DHCP on mgmt0 interface? [yes] no
Step 3: Use zeroconf on mgmt0 interface? [no]
Step 4: Primary IP address? [for example 192.168.10.4] 10.10.10.10
Mask length may not be zero if address is not zero (interface eth0)
Step 5: Netmask? [0.0.0.0] 255.255.255.0
Step 6: Default gateway? [for example 192.168.10.1] 10.10.10.255
Step 7: Primary DNS server?
Step 8: Domain name?
Step 9: Enable IPv6? [yes]
Step 10: Enable IPv6 autoconfig (SLAAC) on mgmt0 interface? [no]
Step 11: Admin password (Enter to leave unchanged)?

To change an answer, enter the step number to return to.
Otherwise hit <enter> to save changes and exit.
Choice:
Configuration changes saved.

To return to the wizard from the CLI, enter the "configuration jump-start"
command from configure mode. Launching CLI...

```

Step 5. Before attempting a remote (for example, SSH) connection to the system, check the mgmt0 interface configuration. Specifically, verify the existence of an IP address. To check the current mgmt0 configuration, enter the following command:

```

switch (config) # show interfaces mgmt0
Interface mgmt0 status:
  Comment:
  Admin up:          yes
  Link up:           yes
  DHCP running:     yes
  IP address:        10.209.28.50
  Netmask:           255.255.255.0
  IPv6 enabled:      yes
  Autoconf enabled: no
  Autoconf route:   yes
  Autoconf privacy: no
  DHCPv6 running:   no
  IPv6 addresses:    1
  IPv6 address:      fe80::202:c9ff:fe63:b55a/64
  Speed:             1000Mb/s (auto)
  Duplex:            full (auto)
  Interface type:    ethernet
  Interface source: physical
  MTU:               1500
  HW address:        00:02:C9:63:B5:5A

  RX bytes:          968810197      TX bytes:          1172590194
  RX packets:        10982099      TX packets:        10921755
  RX mcast packets: 0          TX discards:       0
  RX discards:       0          TX errors:         0
  RX errors:         0          TX overruns:       0
  RX overruns:       0          TX carrier:        0
  RX frame:          0          TX collisions:     0
                                TX queue len:       1000

switch (config) #

```

Step 6. Check the software version embedded in your system, using the command ‘show version’. Compare this version to the latest version that can be retrieved from NVIDIA support site. To upgrade software, please refer to the *MLNX-OS User Manual*.

Remote Connection

Once the network attributes are set, you can access the CLI via SSH or the WebUI via HTTP/ HTTPS.

To access the CLI, perform the following steps:

1. Set up an Ethernet connection between the system and a local network machine using a standard RJ45 connector.
2. Start a remote secured shell (SSH) using the command: `ssh -l <username> <IP_address>`

```
# ssh -l <username> <ip_address>
```

Mellanox MLNX-OS Switch Management

Password:

3. Login as admin (default username is admin, password admin).
4. Once you get the CLI prompt, you are ready to use the system.

For additional information about MLNX-OS, refer to the *MLNX-OS User Manual* at <https://docs.nvidia.com/networking/category/mlnxos>.

FRU Replacements

Power Supply

NVIDIA systems that are equipped with two replaceable power supply units work in a redundant configuration. Either unit may be extracted without bringing down the system.

⚠ Make sure that the power supply unit that you are NOT replacing is showing all green, for both the power supply unit and System Status LEDs.

⚠ Power supply units have directional air flows similar to the fan module. The fan module airflow must coincide with the airflow of all of the power supply units. If the power supply unit airflow direction is different from the fan module airflow direction, the system's internal temperature will be affected. For power supply unit air flow direction, refer to [Air Flow](#).

To extract a power supply unit:

1. Remove the power cord from the power supply unit.
2. Grasping the handle with your hand, push the latch release with your thumb while pulling the handle outward. As the power supply unit unseats, the power supply unit status LEDs will turn off.
3. Remove the power supply unit.
PS Unit Pulled Out

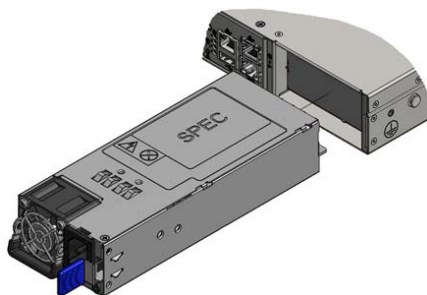

To insert a power supply unit:

1. Make sure the mating connector of the new unit is free of any dirt and/or obstacles.

❗ Do not attempt to insert a power supply unit with a power cord connected to it.

2. Insert the power supply unit by sliding it into the opening, until a slight resistance is felt.
3. Continue pressing the power supply unit until it seats completely. The latch will snap into place, confirming the proper installation.
4. Insert the power cord into the supply connector.
5. Insert the other end of the power cord into an outlet of the correct voltage.

❗ The green power supply unit indicator should light. If it does not, repeat the whole procedure to extract the power supply unit and re-insert it.

Fans

The system can fully operate if one fan FRU is dysfunctional or missing. Failure of more than one fan is not supported.

❗ Make sure that the fans have the air flow that matches the model number. An air flow opposite to the system design will cause the system to operate at a higher (less than optimal) temperature. For power supply unit air flow direction, refer to [Air Flow](#).

To remove a fan unit:

1. Grasping the handle with your right hand, push the latch release with your thumb while pulling the handle outward. As the fan unit unseats, the fan unit status LEDs will turn off.
2. Remove the fan unit.

To insert a fan unit:

1. Make sure the mating connector of the new unit is free of any dirt and/or obstacles.
2. Insert the fan unit by sliding it into the opening until slight resistance is felt. Continue pressing the fan unit until it seats completely.

❗ The green Fan Status LED should light. If not, extract the fan unit and reinsert it. After two unsuccessful attempts to install the fan unit, power off the system before attempting any system debug.

Fan Module Latches

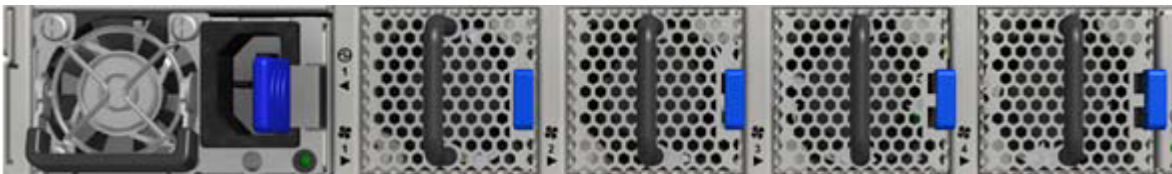

Software Management

The systems include an embedded management CPU card that runs MLNX-OS® management software.

The MLNX-OS systems management package and related documentation can be downloaded at <https://docs.nvidia.com/networking/category/mlnxos>.

InfiniBand Subnet Manager

The InfiniBand Subnet Manager (SM) is a centralized entity running in the system. The SM applies network traffic related configurations such as QoS, routing, partitioning to the fabric devices. You can view and configure the Subnet Manager parameters via the CLI/WebUI. Each subnet needs one subnet manager to discover, activate and manage the subnet.

Each network requires a Subnet Manager to be running in either the system itself (system based) or on one of the nodes which is connected to the fabric (host based).

 No more than two subnet managers are recommended for any single fabric.

The InfiniBand Subnet Manager running on the system supports up to 2048 nodes. If the fabric includes more than 2048 nodes, you may need to purchase NVIDIA's Unified Fabric Manager (UFM®) software package.

Each subnet needs one subnet manager to discover, activate and manage the subnet.

Each network requires a Subnet Manager to be running in either the system itself (system based) or on one of the nodes which is connected to the fabric (host based).

The subnet manager (OpenSM) assigns Local IDentifiers (LIDs) to each port connected to the fabric, and develops a routing table based on the assigned LIDs.

A typical installation using the OFED package will run the OpenSM subnet manager at system start up after the drivers are loaded. This automatic OpenSM is resident in memory, and sweeps the fabric approximately every 5 seconds for new adapters to add to the subnet routing tables.

Upgrading Software (on Managed Systems)

Software and firmware updates are available from the NVIDIA Support website. Check that your current revision is the same one that is on the NVIDIA website. If not upgrade your software. Copy the update to a known location on a remote server within the user's LAN.

Use the CLI or the GUI in order to perform software upgrades. For further information please refer to the Upgrading MLNX-OS® Software section in the [MLNX-OS Software User Manual](#).

Be sure to read and follow all of the instructions regarding the updating of the software on your system.

Managed systems do not require Firmware updating. Firmware updating is done through the MLNX-OS management software. The system comes standard with a management software module for system management called NVIDIA Operating System (MLNX-OS). MLNX-OS® is installed on all SwitchIB® based managed systems. MLNX-OS® includes a CLI, WebUI, SNMP, system management software and IB management software (OpenSM).

Updating Firmware on Externally Managed Systems

There are two methods to update system firmware:

- (Typical) In-band via a switch network port across a cable connecting the server to the switch port.
- (Non-typical) Via the I²C port of the switch using a NVIDIA MTUSB-1 device connecting to a server's USB port on the one end and to the I²C port of the switch on the other.

Firmware updates should normally be conducted in-band. The use of the MTUSB-1 device is intended for cases of debug or firmware corruption and should be conducted by NVIDIA Fields or Support engineers, or by trained users at the customer's site.

Both types of updates require the installation of NVIDIA Firmware Tools (MFT) package. The MFT package and user manual are available for download under <https://network.nvidia.com/products/adapter-software/firmware-tools/>. Please select the package that suits your operating system.

In order to obtain information regarding the externally managed system, you must download the NVIDIA MFT tools from <https://network.nvidia.com/products/adapter-software/firmware-tools/>.

Select and download the release that matches your system. Follow the instructions in the User Manual <https://docs.nvidia.com/networking/category/mft> to get the tools.

Updating Firmware In-band (Typical)

Check the currently programmed firmware on the system and compare it to the latest firmware available under <https://network.nvidia.com/support/firmware/firmware-downloads/> (check under SwitchIB® Switch Systems).

In order to obtain the firmware version of the externally managed system:

1. Obtain the LID of the target system. The following instructions use one of the utilities provided by the installed MFT package. (Other methods are described in the *MFT User Manual*) by performing the following:
 - a. Mark the GUID printed on the inventory pull-out tab of the system.
 - b. Run the command `ibnetdiscover` and search for the row starting with the word "Switch" and indicates the GUID of the system.
 - c. Mark the displayed LID on that row (a decimal number).
2. Run the following command from a host:

```
# flint -d <device> q#
```

3. Compare the results of this command with the latest version for your system posted on <https://network.nvidia.com/support/firmware/firmware-downloads/> (select the Switch-IB System page).
4. If the current version is not the latest version, follow the directions in the MFT User manual to burn the new firmware inband.

For further information, please refer to *MFT User Manual* at <https://docs.nvidia.com/networking/category/mft>.

Interfaces

The systems support the following interfaces:

- Data interfaces - InfiniBand
- 10/100/1000 MbE RJ45 management interface(s)
- USB
- RS232 Console port
- I²C interface
- Reset button
- Status and Port LEDs

In order to review the full configuration options matrix, refer to [Management Interfaces, PSUs and Fans](#).

Data Interfaces

The data interfaces use QSFP28 connectors. The full list of interfaces per system is provided in [Speed and Switching Capabilities](#).

Each QSFP28 port can be connected with QSFP28 cable or connector for 40/56/100 Gb/s. The system offers High Power class 4 transceivers support in all ports.

Speed

InfiniBand speed is auto-adjusted by the InfiniBand protocol. NVIDIA systems support QDR/FDR10/FDR/EDR InfiniBand.

- FDR10 is a non-standard InfiniBand data rate, where each lane of a 4X port runs a bit rate of 10.3125 Gb/s with a 64b/66b encoding, resulting in an effective bandwidth of 40 Gb/s. FDR10 supports 20% more bandwidth over QDR due to better encoding rate.
- FDR is an InfiniBand data rate, where each lane of a 4X port runs a bit rate of 14.0625 Gb/s with 64b/66b encoding, resulting in an effective bandwidth of 56.25 Gb/s.
- EDR is an InfiniBand data rate, where each lane of a 4X port runs a bit rate of 25 Gb/s with 64b/66b encoding, resulting in an effective bandwidth of 100 Gb/s.

I2C/RS232 (Console)

The port labeled “Console **IOIOI**” is an RS232 serial port on the back side of the chassis that is used for initial configuration and debugging. Upon first installation of the system, you need to connect a PC to this interface and configure network parameters for remote connections. Refer to [Configuring Network Attributes](#) to view the full procedure.



- This interface is not found in externally managed systems.
- Apart from the initial configuration, the I²C interface is made exclusively for debugging and troubleshooting. Only FAEs are authorized to connect through it.



Only original NVIDIA cables supplied with the switch package can be used to connect a switch system to the server.

Connecting any cable other than the NVIDIA supplied console cable may cause an I²C hang. Using uncertified cables may damage the I²C interface.

Refer to the [Replacement Parts Ordering Numbers](#) appendix for harness details.

Management

The RJ45 Ethernet ports labeled “MGT Configuring Network Attributes to view the full procedure.



Make sure you use only FCC compliant Ethernet cables.

USB

The USB interface is USB 2.0 compliant and can be used by MLNX-OS software to connect to an external disk for software upgrade or file management. The connector comes in a standard USB shape.

To view the full matrix of the USB configuration options, refer to [Management Interfaces, PSUs and Fans](#).



- USB 1.0 is not supported.
- Do not use excessive force when inserting or extracting the USB disk to and from the connector.

Reset Button

The reset button is located on the rear side of the system next to the fan status LEDs. This reset button requires a tool to be pressed.

 Do not use a sharp pointed object such as a needle or a push pin for pressing the reset button. Use a flat object to push the reset button.

- To reset the system and the CPU of its management board, push the Reset button and keep it pressed for up to 15 seconds.
- To reset the system, the CPU of its management board and the “admin” password, push the Reset button and keep it pressed for at least 15 seconds. You will then be able to enter without a password and set a new password for the user “admin”. In the externally managed systems, the Reset button resets the device.





LEDs

See [LED Notifications](#).

LED Notifications

The system’s LEDs are an important tool for hardware event notification and troubleshooting.

LEDs Symbols



Symbol	Name	Description	Normal Conditions
	System Status LED	Shows the health of the system.	Green/Flashing green when booting
	Fan Status LED	Shows the health of the fans.	Green
	Power Supply Units LEDs	Shows the health of the power supply units.	Green
	Bad Port LED	Lights up when a symbol error is detected on one of the ports.	Off
	Unit Identifier LED	Lights up on command through the CLI.	Off or blue when identifying a port

*This function is currently disabled.

System Status LED

Both of the System Status LEDs (front and back, if exist) supply identical information.

System Status LEDs - Front and Rear Sides

Front Panel	Description	Rear Panel
	Both of the System Status LEDs (front and back) supply identical information.	



⚠ It may take up to five minutes to turn on the system. If the System Status LED shows red after five minutes, unplug the system and call your NVIDIA representative for assistance.

System Status LED Assignments

LED Behavior	Description	Action Required
Solid Green	The system is up and running normally.	N/A
Flashing Green	The system is booting up. This assignment is valid on managed systems only.	Wait up to five minutes for the end of the booting process.
Solid Amber	Major error has occurred. For example, corrupted firmware, system is overheated, etc.	If the System Status LED shows red five minutes after starting the system, unplug the system and call your NVIDIA representative for assistance.

Fan Status LED

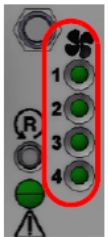
Fan Status LED in SN2700 - Front and Rear Sides

	Both of these LEDs in the red ovals show the fans' status.	
---	--	---

Fan Status Front LED Assignments

LED Behavior	Description	Action Required
Solid Green	All fans are up and running.	N/A
Solid Amber	Error, one or more fans are not operating properly.	The faulty FRUs should be replaced.
Off	System boot	N/A

Fan Status Rear LED Assignments (One LED per Fan)

LED Behavior	Description	Action Required
Solid Green	A specific fan unit is operating.	N/A
Solid Amber*	A specific fan unit is missing or not operating properly.	The fan unit should be replaced.
Off	System boot	N/A

* A limited number of MSB7800-ES2F system units may show Solid Red instead of Solid Amber.



Risk of Electric Shock! With the fan module removed, power pins are accessible within the module cavity. Do not insert tools or body parts into the fan module cavity.

Power Supply Status LEDs

There are two power supply inlets in the system (for redundancy). The system can operate with only one power supply connected. In case the power supply is an FRU, a second power supply unit can be added to support hot-swap ability. Each power supply unit has a single 2 color LED on the right side of the unit, that indicates the status of the unit.

Power Status LED



Rear Side Panel



The primary power supply (PS) unit is located on the left side, and the secondary unit is located on the right side.

Power Supply Unit Status Front LED Assignments

LED Behavior	Description	Action Required
Solid Green	All plugged (one or two) power supplies are running normally.	N/A
Solid Amber	One or both of the power supplies are not operational or not powered up/ the AC power cable is disconnected.	Make sure the AC cable is plugged in and active. If the problem resumes, the FRUs might be faulty, and should then be replaced.
Off	N/A	N/A

The power supply status LEDs on the rear side of the system are located on the PSUs themselves. Each PSU has one LED of its own.

Power Supply Unit Status Rear LED Assignments

LED Behavior	Description	Action Required
Solid Green	The PSU is running normally.	N/A
Flashing Green 1Hz	AC present / Only 12VSB on (PSU off) or PSU in Smart-on state.	Call your NVIDIA representative for assistance.
Amber	AC cord unplugged or AC power lost while the second power supply still has AC input power.	Plug in the AC cord of the faulty PSU.
	PS failure (including voltage out of range and power cord disconnected).	Check voltage. If OK, call your NVIDIA representative for assistance.
Flashing Amber	Power supply warning events where the power supply continues to operate; high temp, high power, high current, slow fan.	Call your NVIDIA representative for assistance.
Off	No AC power to all power supplies.	Call your NVIDIA representative for assistance.

Unit Identification LED

The UID LED is a debug feature, that the user can use to find a particular system within a cluster by turning on the UID blue LED.

To activate the UID LED on a switch system, run:

```
switch (config) # led MGMT uid on
```

To verify the LED status, run:

```
switch (config) # show leds
Module LED Status
-----
MGMT UID Blues
```

To deactivate the UID LED on a switch system, run:

```
switch (config) # led MGMT uid off
```

Bad Port LED

The Bad Port LED indicator is used to indicate symbol errors in one or more system ports.

Bad Port LED Assignments

LED Behavior	Description	Action Required
Off	No symbol errors have been received in last few seconds (normal condition).	N/A
Flashing Amber	Error, one or more ports have received symbol errors. Possible causes are: <ul style="list-style-type: none">• Bad cable• Bad connection• Bad connector	Check symbol error counters on the system UI to identify the ports. Replace the cable on these ports.

Port LEDs

Port LEDs

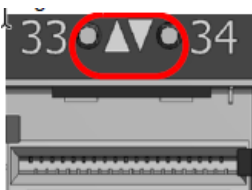

Port LEDs in InfinBand System Mode

LED Behavior	Description	Action Required
Off	Link is down.	Check the cable.
Solid Green	Link is up with no traffic.	N/A
Flashing Green	Link is up with traffic.	N/A
Solid Amber	Link is up.	Wait for the Logical link to raise. Check that the SM is up.
Flashing Amber	A problem with the link.	Check that the SM is up.

In InfiniBand system mode, the LED indicator, corresponding to each data port, will light orange when the physical connection is established (that is, when the unit is powered on and a cable is plugged into the port with the other end of the connector plugged into a functioning port). When a logical connection is made the LED will change to green. When data is being transferred the light will blink green.

Inventory Pull-out Tab

The system's inventory parameters (such as serial number, part number and GUID address) can be extracted from the inventory pull-out tab on the lower right side of the front panel.

Pull-out Tab



Troubleshooting

Problem Indicator	Symptoms	Cause and Solution
LEDs	System Status LED is blinking for more than 5 minutes	<p>Cause: MLNX-OS software did not boot properly and only firmware is running.</p> <p>Solution: Connect to the system via the console port, and check the software status. You might need to contact an FAE if the MLNX-OS software did not load properly.</p>
	System Status LED is red	<p>Cause:</p> <ul style="list-style-type: none"> • Critical system fault (CPU error, bad firmware) • Over temperature <p>Solution:</p> <ul style="list-style-type: none"> • Check environmental conditions (room temperature)
	Fan Status LED is red	<p>Cause: Possible fan issue</p> <p>Solution:</p> <ul style="list-style-type: none"> • Check that the fan is fully inserted and nothing blocks the airflow • Replace the fan FRU if needed
	PSU Status LED is red	<p>Cause: Possible PSU issue</p> <p>Solution:</p> <ul style="list-style-type: none"> • Check/replace the power cable • Replace the PSU if needed
	The activity LED does not light up (InfiniBand)	Make sure that there is an SM running in the fabric.
System boot failure	The last software upgrade failed on x86 based systems	<p>Solution:</p> <ul style="list-style-type: none"> • Connect the RS232 connector (CONSOLE) to a laptop. • Push the system's reset button. • Press the ArrowUp or ArrowDown key during the system boot. GRUB menu will appear. For example: <div data-bbox="671 1503 1394 1816" style="border: 1px solid black; padding: 5px; margin: 10px 0;"> <pre> Default image: 'SX_X86_64 SX_3.4.0008 2014-11-10 20:07:51 x86_64' Press enter to boot this image, or any other key for boot menu Booting default image in 3 seconds. Boot Menu ----- - 0: SX_X86_64 SX_3.4.0008 2014-11-10 20:07:51 x86_64 1: SX_X86_64 SX_3.4.0007 2014-10-23 17:27:34 x86_64 ----- - Use the ArrowUp and ArrowDown keys to select which entry is highlighted. Press enter to boot the selected image or 'p' to enter a password to unlock the next set of features. Highlighted entry is 0: " </pre> </div> <ul style="list-style-type: none"> • Select previous image to boot by pressing an arrow key and choosing the appropriate image.

Problem Indicator	Symptoms	Cause and Solution
System date and time reset	The date and time settings were reset to the default configuration following an AC power loss	<p>Cause:</p> <p>Date and time are reconfigured by the operating system.</p> <p>Solution:</p> <ul style="list-style-type: none"> To set the system's date and time manually, run: <pre data-bbox="751 557 1393 620"># clock set <hh:mm:ss> [<yyyy/mm/dd>]</pre> To verify the configured clock settings, run: <pre data-bbox="751 678 1393 741"># show clock</pre> It is recommended to enable server time synchronization with a Network Time Protocol (NTP) server. To do that, run: <pre data-bbox="751 891 1393 987">> enable # config terminal (config)# ntp server <ntp server ip address></pre> To verify NTP time synchronization is enabled, run: <pre data-bbox="751 1046 1393 1108"># show ntp</pre> <p>For full configuration instructions, please refer to the Onyx User Manual.</p>

Specifications

Feature		Value
Mechanical	Size:	Short: 1.7" (H) x 16.85" (W) x 17" (D), 43.6mm (H) x 428mm (W) x 431.8mm (D) Standard: 1.7" (H) x 16.85" (W) x 27" (D), 43.6mm (H) x 428mm (W) x 685.8mm (D)
	Mounting:	19" Rack mount
	Weight:	Long: 1 PSU: 11.11, 2 PSUs: 11.978 Short: 1 PSU: 7.85, 2 PSUs: 8.63kg
	Speed:	40, 56, 100 Gb/s per port
	Connector cage:	36 QSFP28
Environmental	Temperature:	Operational: 0° to 45° C Non-Operational: -40° to 70° C
	Humidity:	Operational: 10%-85% non-condensing Non-Operational: 10%-90% non-condensing
	Altitude:	Operational: 3050m Non-Operational: 3050m
	Noise level:	70.3 dB(A)
Regulatory	Safety:	CS, cTUVus, CE, CU
	EMC:	CE, FCC, VCCI, ICES, RCM
	RoHS:	RoHS compliant
Power	Input Voltage:	100-127VAC 50/60Hz 4.5A; 200-240 50/60Hz 2.9A
	Global Power Consumption:	SB7700/SB7800/SB7780: Typical power with passive cables (ATIS): 136.08W Max power with passive cables: 203.5W Max power with optical cables (assuming 3.5W per port): 374W SB7790/SB7890: Typical power with passive cables (ATIS): 122.32W Max power with passive cables: 162W Max power with optical cables (assuming 3.5W per port): 332W
Main Devices	CPU:	ICPU (in SB7700/SB7800/SB7780 only): Intel Celeron Dual Core 1047UE (x86)
	Switch IC:	SB7700, SB7790, SB7780: NVIDIA Switch-IB™ SB7800, SB7890: NVIDIA Switch-IB™ 2

Feature		Value
	PCIe (in SB7700/SB7800/ SB7780 only)	4XPCIe Gen2.0
	Memory	4GB RAM DDR3 16GB SSD
Throughput		7.2Tb/s

Appendixes

The document contains the following appendixes:

- [Accessory and Replacement Parts](#)
- [Thermal Threshold Definitions](#)
- [Interface Specifications](#)
- [Disassembly and Disposal](#)
- [Switch Safety Warnings \(Multiple Languages\)](#)

Accessory and Replacement Parts

Ordering Part Numbers for Replacement Parts

OPN	Legacy OPN	Part Description
930-9BRKT-00JC-000	MTEF-KIT-A	Rack installation kit for 1U systems to be mounted into short or standard depth racks
930-9BRKT-00JD-000	MTEF-KIT-B	Telescopic Rack installation kit for standard depth 1U systems to be mounted into standard depth racks
930-9NRKT-00JT-000	MTEF-KIT-S	Rack installation kit for standard depth 1U systems to be mounted into standard depth racks
930-9BPSU-00JX-000	MTEF-PSF-AC-A	460W AC Power Supply w/ P2C air flow (front to rear)
930-9BPSU-00JF-000	MTEF-PSR-AC-A	460W AC Power Supply w/ C2P air flow (rear to front)
930-9BFAN-00IJ-000	MTEF-FANF-A	Fan module w/rear to front airflow fan for SB77X0 switch systems
930-9BFAN-00IY-000	MTEF-FANR-A	Fan module w/front to rear airflow fan for SB77X0 switch systems
HAR000028	-	Harness RS232 2M cable - DB9 to RJ-45 (for managed switches only)
ACC000501	-	NVIDIA® 1U switch black power cord, 250V, 10A, 1830MM and C14 TO C13

Thermal Threshold Definitions

Three thermal threshold definitions are measured by the SwitchIB™ ASICs, and impact the overall switch system operation state as follows:

- Warning - 105°C: On managed systems only: When the ASIC device crosses the 100°C threshold, a Warning Threshold message will be issued by the management software, indicating to system administration that the ASIC has crossed the Warning threshold. Note that this temperature threshold does not require nor lead to any action by hardware (such as switch shutdown).

- Critical - 120°C: When the ASIC device crosses this temperature, the switch firmware will automatically shut down the device.
- Emergency - 130°C: In case the firmware fails to shut down the ASIC device upon crossing its Critical threshold, the device will auto-shutdown upon crossing the Emergency (130°C) threshold.

For thermal threshold definitions in Cumulus Linux, see [Configuring Net-SNMP Event Notification Traps](#) in the [Cumulus Networks Help Center](#).

Interface Specifications

QSFP28 Pin Description

J3 and J6

20	GND	GND	19
21	Rx2n	Rx1n	18
22	Rx2p	Rx1p	17
23	GND	GND	16
24	Rx4n	Rx3n	15
25	Rx4p	Rx3p	14
26	GND	GND	13
27	ModPrsL	SDA	12
28	IntL	SCL	11
29	VccTx	Vcc Rx	10
30	Vcc1	ResetL	9
31	LPMode	ModSelL	8
32	GND	GND	7
33	Tx3p	Tx4p	6
34	Tx3n	Tx4n	5
35	GND	GND	4
36	Tx1p	Tx2p	3
37	Tx1n	Tx2n	2
38	GND	GND	1

QSFP Pin Description

Connector Pin Number	Pin Name	Signal Description
1	GND	Ground
2	Tx2n	Transmitter Inverted Data Input
3	Tx2p	Transmitter Non-Inverted Data Input
4	GND	Ground
5	Tx4n	Transmitter Inverted Data Input
6	Tx4p	Transmitter Non-Inverted Data Input

Connector Pin Number	Pin Name	Signal Description
7	GND	Ground
8	Mod-SelL	Module Select
9	ResetL	Module Reset
10	Vcc Rx	+3.3 V Power supply receiver
11	SCL	2-wire serial interface clock
12	SDA	2-wire serial interface data
13	GND	Ground
14	Rx3p	Receiver Non-Inverted Data Output
15	Rx3n	Receiver Inverted Data Output
16	GND	Ground
17	Rx1p	Receiver Non-Inverted Data Output
18	Rx1n	Receiver Inverted Data Output
19	GND	Ground
20	GND	Ground
21	Rx2n	Receiver Inverted Data Output 3
22	Rx2p	Receiver Non-Inverted Data Output 3
23	GND	Ground
24	Rx4n	Receiver Inverted Data Output 4
25	Rx4p	Receiver Non-Inverted Data Output 4
26	GND	Ground
27	ModPrsL	Module Present
28	IntL	Interrupt
29	Vcc Tx	+3.3 V Power supply transmitter
30	Vcc 1	+3.3 V Power Supply
31	LPMode	Low Power Mode
32	GND	Ground
33	Tx3p	Transmitter Non-Inverted Data Input
34	Tx3n	Transmitter Inverted Data Input
35	GND	Ground
36	Tx1p	Transmitter Non-Inverted Data Input
37	Tx1n	Transmitter Inverted Data Input
38	GND	Ground

QSFP Connector Male and Female Views

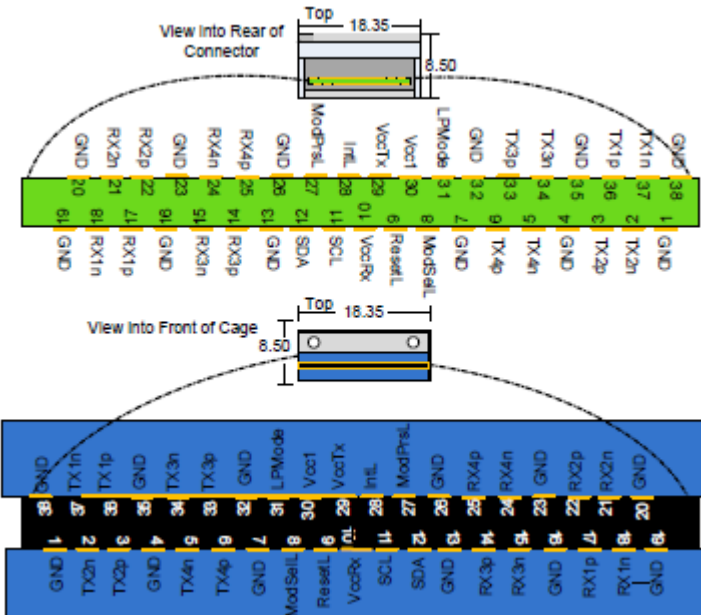

RJ-45 CONSOLE and I²C Interface



RJ-45 Console and I²C interfaces are integrated in the same connector. Due to that, connecting any cable other than the Mellanox supplied console cable may cause an I²C hang.

Using uncertified cables may damage the I²C interface. Refer to the [Replacement Parts Ordering Numbers](#) appendix for harness details.

Signal	Pin#	Color
Not connected	1	G/W
I ² C_SCL	2	G
TXD	3	O/W
Not connected	4	Bl
GND	5	Bl/W
RXD	6	O
I ² C_SDA	7	Br/W
Not connected	8	Br

RJ45 to DB9 Harness Pinout

In order to connect a host PC to the Console RJ45 port of the system, a RS232 harness cable (DB9 to RJ45) is supplied.

RJ45 to DB9 Harness Pinout

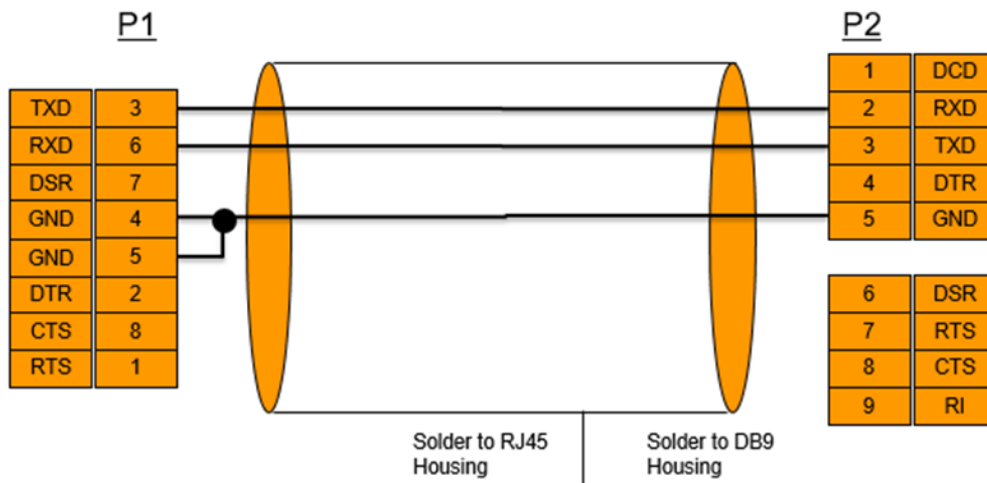

Disassembly and Disposal

Disassembly Procedure

To disassemble the system from the rack:

1. Unplug and remove all connectors.
2. Unplug all power cords.
3. Remove the ground wire.
4. Unscrew the center bolts from the side of the system with the bracket.

⚠ Support the weight of the system when you remove the screws so that the system does not fall.

5. Slide the system from the rack.
6. Remove the rail slides from the rack.
7. Remove the caged nuts.

Disposal

According to the WEEE Directive 2002/96/EC, all waste electrical and electronic equipment (EEE) should be collected separately and not disposed of with regular household waste. Dispose of this product and all of its parts in a responsible and environmentally friendly way.

Follow the instructions found at http://www.mellanox.com/page/dismantling_procedures for proper disassembly and disposal of the switch, according to the WEEE directive.



Switch Safety Warnings (Multiple Languages)

Safety warnings are provided in multiple languages for your convenience:

- [Switch Safety Warnings \(English\)](#)
 - [Taiwan RoHS Declaration - Switch Systems](#)
 - [Taiwan RoHS Declaration - Gateway Systems](#)
 - [Taiwan BSMI Class A Statement - Warning to the User!](#)
- [Nordic Countries Notices](#)
- [安裝安全性警告 \(Simplified Chinese\)](#)
 - [China CCC Warning Statement](#)
 - [Taiwan RoHS Declaration - Switch Systems](#)
 - [Taiwan RoHS Declaration - Gateway Systems](#)
 - [Taiwan BSMI Class A Statement - Warning to the User!](#)
- [安裝安全性警告 \(Chinese\)](#)
 - [China CCC Warning Statement](#)
 - [Taiwan RoHS Declaration - Switch Systems](#)
 - [Taiwan RoHS Declaration - Gateway Systems](#)
 - [Taiwan BSMI Class A Statement - Warning to the User!](#)
- [Avertissements de sécurité pour l'installation \(French\)](#)
- [Installation Sicherheitshinweise \(German\)](#)
- [Advertencias de seguridad de instalación \(Spanish\)](#)
- [Предупреждения по технике безопасности при установке \(Russian\)](#)
- [Avertisment privind siguranța la instalare \(Romanian\)](#)
- [Sigurnosna upozorenja za instaliranje \(Croatian\)](#)
- [Avvertenze di sicurezza per l'installazione \(Italian\)](#)
- [Montaj Güvenlik Uyarıları \(Turkish\)](#)
- [Japan VCCI Statement](#)
- [\(Hebrew\) הוראות בטיחות בהתקנה](#)

 Note that not all warnings may apply to all models.

Switch Safety Warnings (English)



Installation Instructions

Read all installation instructions before connecting the equipment to the power source.



Bodily Injury Due to Weight

Use enough people to safely lift this product.

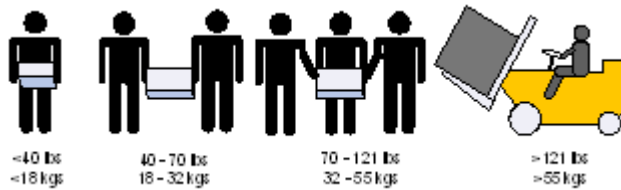

 Heavy Equipment

This equipment is heavy and should be moved using a mechanical lift to avoid injuries.

 Risk of Electric Shock!

- With the fan module removed power pins are accessible within the module cavity. Do not insert tools or body parts into the fan module cavity.
- For AC powered switch systems: Disconnecting one power supply only disconnects one module. To isolate the unit completely, all connected power supplies must be disconnected.



In QM97X0/HGX H100 switch systems: for 200-240Vac use only

 Over-temperature

This equipment should not be operated in an area with an ambient temperature exceeding the maximum value listed in the product specifications. Moreover, to guarantee proper ventilation, allow at least 8 cm (3 inches) of clearance around the ventilation openings.

 Stacking the Chassis

The chassis should not be stacked on any other equipment. If the chassis falls, it can cause bodily injury and equipment damage.

 Redundant Power Supply Connection (OPTIONAL)—Electrical Hazard

This product includes a redundant power or a blank in its place. In case of a blank power supply, do not operate the product with the blank cover removed or not securely fastened.

 Double Pole/Neutral Fusing

This system has double pole/neutral fusing. Remove all power cords before opening the cover of this product or touching any internal parts.



Multiple Power Inlets

Risk of electric shock and energy hazard. The PSUs are all independent. Disconnect all power supplies to ensure a powered down state inside of the switch platform.



During Lightning—Electrical Hazard

During periods of lightning activity, do not work on the equipment or connect or disconnect cables.



Copper Cable Connecting/Disconnecting

Copper cables are heavy and not flexible, as such they should be carefully attached to or detached from the connectors. Refer to the cable manufacturer for special warnings/instructions.



Rack Mounting and Servicing

When this product is mounted or serviced in a rack, special precautions must be taken to ensure that the system remains stable. In general, the rack should be filled with equipment starting from the bottom to the top.



Equipment Installation

This equipment should be installed, replaced, and/or serviced only by trained and qualified personnel.



Equipment Disposal

Disposal of this equipment should be in accordance to all national laws and regulations.



Local and National Electrical Codes

This equipment should be installed in compliance with local and national electrical codes.



Installation Codes

This device must be installed according to the latest version of the country national electrical codes. For North America, equipment must be installed in accordance to the applicable requirements in the US National Electrical Code and the Canadian Electrical Code.



Battery Replacement

Warning: Replace only with UL Recognized battery, certified for maximum abnormal charging current not less than 4mA. There is a risk of explosion should the battery be replaced with a battery of an incorrect type. Dispose of used batteries according to the instructions.



UL Listed and CSA Certified Power Supply Cord

For North American power connection, select a power supply cord that is UL Listed and CSA Certified, 3 - conductor, [16 AWG], terminated with a molded plug rated at 125 V, [13 A], with a minimum length of 1.5m [six feet] but no longer than 4.5m.

For European connection, select a power supply cord that is internationally harmonized and marked “<HAR>”, 3 - conductor, minimum 1.0 mm² wire, rated at 300 V, with a PVC insulated jacket. The cord must have a molded plug rated at 250 V, 10 A.



Installation Codes

This device must be installed according to the latest version of the country's national electrical codes. For North America, equipment must be installed in accordance to the applicable requirements in the US National Electrical Code and the Canadian Electrical Code.



Interconnection of Units

Cables for connecting to the unit RS232 and Ethernet Interfaces must be UL certified type DP-1 or DP-2. (Note: when residing in non LPS circuit.)



Overcurrent Protection

A readily accessible Listed branch circuit overcurrent protective device rated 20 A must be incorporated in the building wiring.

Acoustic Level Warning

The acoustic level listed in Specifications section represents product noise measured in accordance with ISO 7779 under nominal conditions. The actual noise level can vary depending on the installation conditions, including but not limited to the number of racks in the installation, the overall installation size, rack and other equipment material and noise levels, fan faults, room temperature, room configuration, and employee location in relation to the equipment. The data-center owner should manage effective hearing conservation as per the OSHA standard to protect employees against over and extended exposure to noise.



Do Not Use the Switch as a Shelf or Work Space

Caution: Slide/rail mounted equipment is not to be used as a shelf or a work space. The rails are not intended for sliding the unit away from the rack. It is for permanent installation at final resting place only, not used for service and maintenance.



WEEE Directive

According to the WEEE Directive 2002/96/EC, all waste electrical and electronic equipment (EEE) should be collected separately and not disposed of with regular household waste. Dispose of this product and all of its parts in a responsible and environmentally-friendly way.



Country of Norway Power Restrictions

This unit is intended for connection to a TN power system and an IT power system of Norway only.

Taiwan RoHS Declaration - Switch Systems

設備名稱：伺服器						
單元Unit	限用物質及其化學符號					
	鉛Lead (Pb)	汞Mercury (Hg)	鎘Cadmium (Cd)	六價鉻 Hexavalent chromium (Cr ⁺⁶)	多溴聯苯 Polybrominated biphenyls (PBB)	多溴二苯醚 Polybrominated diphenyl ethers (PBDE)
印刷電路板	—	○	○	○	○	○
金屬外殼	○	○	○	○	○	○
塑膠件	○	○	○	○	○	○
PCB 板電子零件	—	○	○	○	○	○
備考1. “超出0.1 wt %”及“超出0.01 wt %”係指限用物質之百分比含量超出百分比含量基準值。						
備考2. “○”係指該項限用物質之百分比含量未超出百分比含量基準值。						
備考3. “—”係指該項限用物質為排除項目。						

Taiwan RoHS Declaration - Gateway Systems

設備名稱： 閘道器						
單元Unit	限用物質及其化學符號					
	鉛Lead (Pb)	汞Mercury (Hg)	鎘Cadmium (Cd)	六價鉻 Hexavalent chromium (Cr ⁺⁶)	多溴聯苯 Polybrominated biphenyls (PBB)	多溴二苯醚 Polybrominated diphenyl ethers (PBDE)
印刷電路板	—	○	○	○	○	○
金屬外殼	○	○	○	○	○	○
塑膠件	○	○	○	○	○	○
PCB 板電子零件	—	○	○	○	○	○

備考1. “超出0.1 wt %”及“超出0.01 wt %”係指限用物質之百分比含量超出百分比含量基準值。

備考2. “○”係指該項限用物質之百分比含量未超出百分比含量基準值。

備考3. “—”係指該項限用物質為排除項目。

Taiwan BSMI Class A Statement - Warning to the User!

警告：為避免電磁干擾，本產品不應安裝或使用於住宅環境。

Nordic Countries Notices



In Finland: "Laite on liitettävä suojakoskettimilla varustettuun pistorasiaan"



In Norway: "Apparatet må tilkoples jordet stikkontakt"



In Sweden: "Apparaten skall anslutas till jordat uttag"

安裝安全性警告 (Simplified Chinese)



安裝指示

本設備附有備援電源供應器或在適當位置配有空白蓋板。



因重量導致的人身受傷

為了安全起見，請安排足夠的人員以合力抬起本產品。

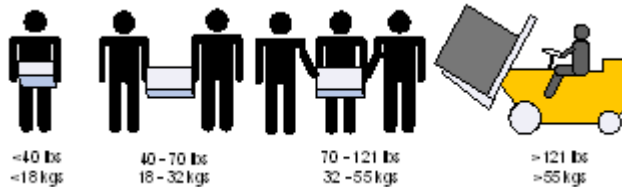

重設備

本設備極重，應使用機械式起重機來搬移，以避免人員受傷。



有觸電的危險

有觸電的危險！拆除風扇模組後，即可接觸到模組空腔內的電源針腳。請勿將工具或機身零件插入到風扇模組空腔內。



溫度過高

本設備不應在超過所建議的最高環境溫度的區域中運作：45°C (113°F)。此外，為了保證氣流的流通正常，請在通風口旁保留至少 8 公分 (3 英吋) 的間距。



堆疊機箱

機箱不應堆疊在任何其他設備上。如果機箱掉落，可能造成人員受傷與設備損壞。



複式電源連接時的電擊危險

本設備附有備援電源供應器或在適當位置配有空白蓋板。如果是電源供應器空白蓋板，在空白蓋板已取下或未牢牢固訂的情況下，請勿操作本產品。



雙極/中性保險絲

本系統具有雙極/中性保險絲。請拔掉所有電源線後，再打開本產品的蓋板或碰觸任何內部零件。



多電源輸入座

電擊與能源危害的危險。所有 PSU 均各自獨立。將所有電源供應器斷電，確保交換器平台內部在電源關閉狀態。



閃電時的電擊危險

在閃電期間，不要使用本設備或連接或拔下纜線。



機架安裝與維修

此產品已安裝在機架中或在機架中維修時，必須採取特定預防措施以確保系統維持穩定。一般您應該將設備從底部到頂端放滿機架。



設備安裝

本設備僅限由經過訓練與/或合格的人員安裝、更換或維修。



設備棄置

棄置本設備應遵照所有國內法規。



當地與國家電氣法規

請遵照當地與國家電氣法規安裝本設備。



安裝法規

請務必遵循最新版的國家電氣法規，安裝本設備。在北美地區，請務必遵循美國國家電工法規和加拿大電工法規中的適用規定，安裝本設備。



更換電池

警告：只能以 UL 認可電池，且取得最大異常充電電流低於 4mA 認證的電池進行更換。
若更換錯誤類型的電池，會有爆炸的危險。
請依據指示棄置廢電池。



UL 列名和 CSA 認證電源線

北美地區在接上電源時，請選用獲得 UL 列名和 CSA 認證、三個導體、[16 AWG] 附成型插頭，額定值為 125 V、[13 A]，長度至少 1.5 公尺 [六英尺]，但不超過 4.5 公尺的電源線。
歐洲地區在接上電源時，請選用國際協調式且標示有 <HAR> 字樣、三個導體、標稱截面至少 1.0 平方公厘，額定值為 300 V，採用 PVC 絕緣的電源線。電源線需有成型插頭，額定值為 250 V, 10 A。



高漏電流

警告：高漏電流；必須執行地線連接，然後再連接電源供應器。



安裝法規

請務必遵循最新版的國家電氣法規，安裝本設備。在北美地區，請務必遵循美國國家電工法規和加拿大電工法規中的適用規定，安裝本設備。



互連設備

連接至 RS232 設備和乙太網路介面的纜線必須是 UL 認證類型 DP-1 或 DP-2。(請注意位於非 LPS 電路時)。



過電流保護：準備好使用的列名分支電路過電流保護裝置最大額定值 20 A 必須整合在配線中。

噪音級別警告

規格部分中列出的噪音級別代表在標定條件下根據 ISO 7779 標準測量出的產品噪音。實際噪音級別可能因安裝情況而異，影響因素包括但不限於安裝所使用的機架數量、安裝所占用的整體空間大小、機架和其他設備所使用的材料及其噪音水平、風扇故障、室溫、房間佈置以及員工與設備的相對位置。數據中心所有者應根據 OSHA 標準進行有效的聽力保護管理，以便保護員工，使其聽力免受過大噪音的傷害，並避免讓員工長時間待在充滿噪音的環境中。



請勿將交換機作為機架與工作空間使用

小心：具有滑軌 / 導軌設備不可用作機架或工作空間。導軌不適用於將設備滑出機架使用。仅限永久安裝在最後安置區域時使用，不可用於維修和保養。



WEEE 指令

根據 WEEE 指令 2002/96/EC，所有廢棄的電氣與電子設備 (EEE)，應分開集中，而且不應與一般家庭廢棄物一起棄置。請以負責和環保的方式棄置本產品及其所有零件。



挪威國家電源限制

本設備仅限連接至挪威的 TN 電源系統和 IT 電源系統。

Taiwan RoHS Declaration - Switch Systems

設備名稱：交換器		型號（型式）： Mellanox Switch Systems				
單元Unit	限用物質及其化學符號					
	鉛Lead (Pb)	汞Mercury (Hg)	鎘Cadmium (Cd)	六價鉻 Hexavalent chromium (Cr ⁺⁶)	多溴聯苯 Polybrominated biphenyls (PBB)	多溴二苯醚 Polybrominated diphenyl ethers (PBDE)
印刷電路板	—	○	○	○	○	○
金屬外殼	○	○	○	○	○	○
塑膠件	○	○	○	○	○	○
PCB 板電子零件	—	○	○	○	○	○

備考1. “超出0.1 wt %”及“超出0.01 wt %”係指限用物質之百分比含量超出百分比含量基準值。

備考2. “○”係指該項限用物質之百分比含量未超出百分比含量基準值。

備考3. “—”係指該項限用物質為排除項目。

Taiwan RoHS Declaration - Gateway Systems

設備名稱： 閘道器						
單元Unit	限用物質及其化學符號					
	鉛Lead (Pb)	汞Mercury (Hg)	鎘Cadmium (Cd)	六價鉻 Hexavalent chromium (Cr ⁺⁶)	多溴聯苯 Polybrominated biphenyls (PBB)	多溴二苯醚 Polybrominated diphenyl ethers (PBDE)
印刷電路板	—	○	○	○	○	○
金屬外殼	○	○	○	○	○	○
塑膠件	○	○	○	○	○	○
PCB 板電子零件	—	○	○	○	○	○

備考1. “超出0.1 wt %”及“超出0.01 wt %”係指限用物質之百分比含量超出百分比含量基準值。

備考2. “○”係指該項限用物質之百分比含量未超出百分比含量基準值。

備考3. “—”係指該項限用物質為排除項目。

Taiwan BSMI Class A Statement - Warning to the User!

警告：為避免電磁干擾，本產品不應安裝或使用於住宅環境。

安裝安全性警告 (Chinese)

安裝指示

本設備附有備援電源供應器或在適當位置配有空白蓋板。

因重量導致的人身受傷

为了安全起见，请安排足够的人员以合力抬起本产品。

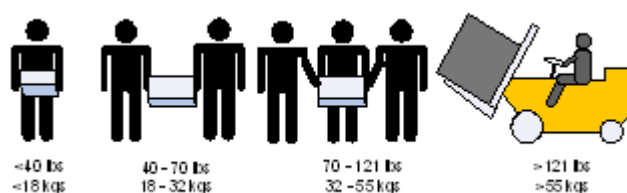

重设备

本设备极重，应使用机械式起重机来搬移，以避免人员受伤。

有触电的危险

有触电的危险！拆除风扇模组后，即可接触到机箱内模组空缺处的电源针脚。请勿将工具或机身零件放入机箱内风扇模组空缺处。

温度过高

本设备不应在超过所建议的最高环境温度的区域中运作： 45°C (113°F)。此外，为了保证气流的流通正常，请在通风口旁保留至少 8 公分 (3 英寸) 的间距。

堆叠机箱

机箱不应堆叠在任何其他设备上。如果机箱掉落，可能造成人员受伤与设备损坏。

备用电源供应器连接时的电击危险

本设备附有备用电源供应器或在适当位置配有空白盖板。有关电源供应器，在空白盖板已取下或未牢牢固定的情况下，请勿操作本产品

双极/中性保险丝

本系统具有双极 / 中性保险丝。请拔掉所有电源线后，再打开本产品的盖板或碰触任何内部零件。

多电源输入座

电击与能源危害的危险。所有 PSU 均各自独立。请将所有电源供应器断电，以确保交换器设备内部的电源为关闭状态。

铜缆线的连接与移除

铜电缆重且不易弯折，因此应仔细连接或从连接器端口分离。请参阅电缆制造商了解特殊警告/说明。



机架安装与维修

此产品已安装在机架中或在机架中维修时，必须采取特定预防措施以确保系统维持稳定。一般您应该将设备从底部到顶端放满机架。



设备安装

本设备仅限由经过训练与 / 或合格的人员安装、更换或维修。



设备弃置

弃置本设备应遵照所有国内法规。



当地与国家电气法规

请遵照当地与国家电气法规安装本设备。



安装法规

请务必遵循最新版的国家电气法规，安装本设备。在北美地区，请务必遵循美国国家电工法规和加拿大电工法规中的适用规定，安装本设备。



更换电池

警告：只能以 UL 认可电池，且取得最大异常充电电流低于 4mA 认证的电池进行更换。若更换错误类型的电池，会有爆炸的危险。请依据指示弃置废电池。



UL 列名和 CSA 认证电源线

北美地区在接上电源时，请选用获得 UL 列名和 CSA 认证 3- 导体 [16AWG] 附成型插头，额定值为 125 V、[13 A]，长度至少 1.5 公尺 [六英尺]，但不超过 4.5 公尺的电源线。

欧洲地区在接上电源时，请选用国际协调式且标示有 <HAR> -3 字样、导体标示截面至少 1.0 平方公厘，额定值为 300 V，采用 PVC 绝缘的电源线。电源线需有成型插头，额定值为 250 V, 10 A。



高漏电流

警告：高漏电流；必须执行地线连接，然后再连接电源供应器。



安装法规

请务必遵循最新版的国家电气法规，安装本设备。在北美地区，请务必遵循美国国家电工法规和加拿大电工法规中的适用规定，安装本设备。



互连设备

连接至 RS232 设备和以太网路介面的缆线必须是 UL 认证类型 DP-1 或 DP-2。(请注意- 若放置于无 LPS 电路时)



過電流保護：準備好使用的列名分支電路過電流保護裝置最大額定值 20 A 必須整合在配線中。

噪音级别警告

规格部分中列出的噪音级别代表在标定条件下根据 ISO 7779 标准测量出的产品噪音。实际噪音级别可能因安装情况而异，影响因素包括但不限于安装所使用的机架数量、安装所占用的整体空间大小、机架和其他设备所使用的材料及其噪音水平、风扇故障、室温、房间布置以及员工与设备的相对位置。数据中心所有者应根据 OSHA 标准进行有效的听力保护管理，以便保护员工，使其听力免受过大噪音的伤害，并避免让员工长时间待在充满噪音的环境中。



切换开关不可用作机架或工作空间

小心：滑軌/導軌安裝設備不可用作機架或工作空間。導軌不適用於將設備滑出機架使用。僅限永久安裝在最後安置區域時使用，不可用於維修和保養。



WEEE 指令

根據 WEEE 指令 2002/96/EC，所有廢棄的電氣與電子設備 (EEE)，應分開集中，而且不應與一般家庭廢棄物一起棄置。請以負責和環保的方式棄置本產品及其所有零件。



挪威國家電源限制

本設備僅限連接至挪威的 TN 電源系統和 IT 電源系統。

China CCC Warning Statement

在维修的时候一定要断开所有电源 (English translation “disconnect all power sources before service”)



For non tropical use:

安全说明和标记	汉文	“仅适用于非热带气候条件下安全使用。”
	藏文	《འགོག་ཡོད་པའི་སྐབས་ལ་གྱི་གནས་སུ་གཤམ་མེད་པའི་སྐབས་ལ་ཉེན་མེད་བེད་སྤྱོད་བྱས་འཇུག།》
	蒙古文	“ཚོ་བའི་སྐབས་ལ་གྱི་གནས་སུ་གཤམ་མེད་པའི་སྐབས་ལ་ཉེན་མེད་བེད་སྤྱོད་བྱས་འཇུག།”
	壮文	Dan hab yungh youq gij dienheiq diuzgen mbouj dwg diegndat haenx ancienz sawjyungh.
	维文	غەيرى ئىسسىق بەلباغ ھاۋا كىلىماتى شارائىتىدىلا بىخەتەر ئىشلەتكىلى بولىدۇ



For altitude 2000 meter and below:

安全说明和标记	汉文	仅适用于海拔2000m以下地区安全使用。
	藏文	《2000m རྒྱུ་མཚོ་དོས་ལས་མཐོ་ཚད་མི་2000མན་གྱི་སྐབས་ལ་ཉེན་མེད་བེད་སྤྱོད་བྱས་འཇུག།》
	蒙古文	“རྒྱ་མཚོ་དོས་ལས་མཐོ་ཚད་མི་2000མན་གྱི་སྐབས་ལ་ཉེན་མེད་བེད་སྤྱོད་བྱས་འཇུག།”
	壮文	Dan hab yungh youq gij digih haijbaz 2000m doxroengz haenx ancienz sawjyungh.
	维文	دېڭىز يۈزىدىن 2000 مېتىر تۆۋەن رايونلاردا بىخەتەر ئىشلەتكىلى بولىدۇ

Warning for Class A:

声 明

此为 A 级产品，在生活环境中，该产品可能会造成无线电干扰。在
种情况下，可能需要用户对其干扰采取切实可行的措施。

English translation of above statement

This is a Class A product. In a domestic environment this product may cause radio interference, in which case the user may be required to take adequate measures.

Taiwan RoHS Declaration - Switch Systems

設備名稱：交換器		型號（型式）： Mellanox Switch Systems				
單元Unit	限用物質及其化學符號					
	鉛Lead (Pb)	汞Mercury (Hg)	鎘Cadmium (Cd)	六價鉻 Hexavalent chromium (Cr ⁺⁶)	多溴聯苯 Polybrominated biphenyls (PBB)	多溴二苯醚 Polybrominated diphenyl ethers (PBDE)
印刷電路板	—	○	○	○	○	○
金屬外殼	○	○	○	○	○	○
塑膠件	○	○	○	○	○	○
PCB 板電子零件	—	○	○	○	○	○
備考1. “超出0.1 wt %” 及 “超出0.01 wt %” 係指限用物質之百分比含量超出百分比含量基準值。						
備考2. “○” 係指該項限用物質之百分比含量未超出百分比含量基準值。						
備考3. “—” 係指該項限用物質為排除項目。						

Taiwan RoHS Declaration - Gateway Systems

設備名稱： 開道器						
單元Unit	限用物質及其化學符號					
	鉛Lead (Pb)	汞Mercury (Hg)	鎘Cadmium (Cd)	六價鉻 Hexavalent chromium (Cr ⁺⁶)	多溴聯苯 Polybrominated biphenyls (PBB)	多溴二苯醚 Polybrominated diphenyl ethers (PBDE)
印刷電路板	—	○	○	○	○	○
金屬外殼	○	○	○	○	○	○
塑膠件	○	○	○	○	○	○
PCB 板電子零件	—	○	○	○	○	○

備考1. “超出0.1 wt %”及“超出0.01 wt %”係指限用物質之百分比含量超出百分比含量基準值。

備考2. “○”係指該項限用物質之百分比含量未超出百分比含量基準值。

備考3. “—”係指該項限用物質為排除項目。

Taiwan BSMI Class A Statement - Warning to the User!

警告：為避免電磁干擾，本產品不應安裝或使用於住宅環境。

Avertissements de sécurité pour l'installation (French)



Instructions d'installation

Veillez lire la totalité des instructions d'installation avant de relier l'équipement au secteur.



Blessures à cause du poids

Prévoyez assez de personnel pour soulever ce produit en toute sécurité.

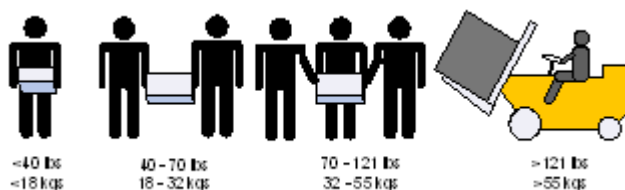

Équipement lourd

Cet équipement est lourd et doit être déplacé avec un système de levage mécanique pour éviter les blessures.



Danger d'électrocution

Danger d'électrocution ! Lorsque le module de ventilation est retiré, les broches d'alimentation sont exposées dans l'emplacement du module. NE PAS insérer d'outils ou la main dans l'emplacement du module.



Surchauffe

Cet équipement ne doit pas être en service dans un local dont la température dépasse le maximum recommandé de 45°C (113°F). En outre et pour garantir une circulation d'air correcte, laisser un espace d'au moins 8 cm (3") autour des orifices de ventilation.



Châssis empilé sur d'autres équipements

Le châssis ne doit pas être empilé sur d'autres équipements. S'il tombe, il peut endommager l'équipement ou entraîner des blessures.



Connexion de l'alimentation redondante : danger d'électrocution

Ce produit est équipé d'une alimentation redondante ou d'un cache si elle est absente. Dans ce dernier cas, ne pas faire fonctionner le produit si le cache est retiré ou mal fixé.



Fusibles phase/neutre

Ce système dispose de fusibles phase/neutre. Débranchez tous les cordons d'alimentation avant d'ouvrir le capot ou de toucher tout élément à l'intérieur.



Plusieurs prises d'alimentation

Risque et danger d'électrocution. Les alimentations sont toutes indépendantes. Pour s'assurer que le commutateur est bien hors tension, débranchez toutes les alimentations.



En cas d'orage, danger d'électrocution

Pendant un orage, ne pas travailler sur l'équipement ni brancher ou débrancher des câbles.



Connexion et déconnexion du câble en cuivre

Les câbles en cuivre sont lourds et peu flexibles. Par conséquent, il faut procéder avec soin pour les brancher ou les débrancher des connecteurs. Consulter le fabricant du câble pour obtenir des instructions ou des avertissements spécifiques.



Montage en rack et maintenance

Lors du montage ou de la maintenance de ce produit dans un rack, il faut faire spécialement attention pour s'assurer que l'ensemble reste stable. En règle générale, le rack doit être rempli en commençant par le bas.



Installation de l'équipement

Cet équipement ne doit être installé, remplacé et maintenu que par un personnel formé et qualifié.



Mise au rebut de l'équipement

La mise au rebut de cet équipement doit se faire conformément à toutes les lois et réglementations nationales.



Codes électriques locaux et nationaux

Cet équipement doit être installé conformément aux codes électriques locaux et nationaux.



Codes d'installation

Cet appareil doit être installé conformément à la version la plus récente des codes électrique nationaux. En Amérique du Nord, l'équipement doit être installé en respectant les exigences de l'US National Electrical Code et du Code canadien de l'électricité.



Remplacement de la batterie

Avertissement: ne remplacer qu'avec une batterie UL, certifiée pour accepter un courant de charge anormal maximal supérieur ou égal à 4 mA. Si la batterie n'est pas remplacée par un type correct, il y a un risque d'explosion. Les batteries usagées doivent être mises au rebut conformément aux instructions.



Cordon d'alimentation UL Listed et certifié CSA

Pour le branchement électrique en Amérique du Nord, utiliser un cordon d'alimentation UL Listed et CSA Certified, à 3 conducteurs [calibre 16 AWG], avec une prise moulée 125 V [13 A], faisant au moins 1,5 m de long [six pieds] et au plus 4,5 m.

Pour le branchement électrique en Europe, utiliser un cordon d'alimentation au format international harmonisé (marqué <HAR>), à 3 conducteurs d'au moins 1 mm² de section, 300 V, avec une gaine isolante en PVC. Le cordon doit avoir une prise moulée 250 V 10 A.



Courant de fuite élevé

Avertissement: courant de fuite élevé, une connexion à la terre est indispensable avant de brancher l'alimentation.



Codes d'installation

Cet appareil doit être installé conformément à la version la plus récente des codes électrique nationaux. En Amérique du Nord, l'équipement doit être installé en respectant les exigences de l'US National Electrical Code et du Code canadien de l'électricité.



Interconnexion des unités

Les câbles de connexion aux interfaces RS232 et Ethernet de l'appareil doivent être certifié UL de type DP-1 ou DP-2. (Note : en cas d'installation sur un circuit dont la puissance n'est pas limitée)



Protection contre les surintensités : le câblage de l'immeuble doit intégrer un dispositif certifié de protection contre les surintensités, calibré à 20 A et aisément accessible.

Avertissement de niveau acoustique

Le niveau acoustique indiqué dans la section Spécifications correspond au bruit émis par le produit conformément à la norme ISO 7779 dans des conditions nominales. Le niveau sonore réel peut varier selon les conditions d'installation, y compris, mais sans s'y limiter, le nombre de racks relatifs à l'installation, les dimensions globales de l'installation, le rack et les autres équipements et/ou niveaux de bruit existants, les défauts de ventilation, la température de la pièce, la configuration de la pièce et la disposition de l'opérateur par rapport à l'équipement. Le propriétaire du Data Center doit proposer des mesures efficaces de protection auditive en conformité avec la norme OSHA, de manière à protéger ses employés contre une exposition prolongée au bruit.



Ne pas utiliser comme étagère ou plan de travail

Attention: un équipement coulissant ou monté sur rail ne doit pas servir d'étagère ni de plan de travail. Les rails ne sont pas destinés à faire coulisser l'unité hors du rack. Ils sont destinés à une installation permanente à l'emplacement final, pas pour l'entretien ni la maintenance.



Directive DEEE

Selon la Directive 2002/96/CE (DEEE), tous les déchets d'équipements électriques et électroniques (EEE) doivent être collectés séparément et ne pas être mis au rebut avec les déchets ménagers habituels. Ce produit et toutes ses pièces doivent être mis au rebut d'une manière responsable, respectant l'environnement.



Restrictions concernant l'alimentation pour la Norvège

Cet appareil est prévu pour être relié à un système d'alimentation TN et un système d'alimentation informatique de Norvège uniquement.

Installation Sicherheitshinweise (German)



Installationsanleitungen

Lesen Sie alle Installationsanleitungen, bevor Sie das Gerät an die Stromversorgung anschließen.



Verletzungsgefahr wegen des Gewichts

Um das Produkt sicher anzuheben, genügend Personen einsetzen.



Schweres Gerät

Dieses Gerät ist schwer und muss mit einem mechanischen Hebegerät verschoben werden, um Verletzungen zu vermeiden.



Stromschlagrisiko

Stromschlagrisiko! Bei abgenommenem Ventilatormodul sind die Stromkontakte in der Modulvertiefung zugänglich. Es dürfen KEINE Werkzeuge oder Körperteile in die Vertiefung des Ventilatormoduls gelangen.



Übertemperatur

Dieses Gerät sollte nicht in einem Bereich mit einer Umgebungstemperatur über der maximal empfohlenen Temperatur von 45 °C (113 °F) betrieben werden. Es ist ein Luftstrom von 200 LFM bei maximaler Umgebungstemperatur erforderlich. Außerdem sollten mindestens 8 cm (3 in.) Freiraum um die Belüftungsöffnungen sein, um einen einwandfreien Luftstrom zu gewährleisten.



Stapeln des Chassis

Das Chassis sollte nicht auf andere Geräte gestapelt werden. Wenn das Chassis herunterfällt, kann es zu Verletzungen und Beschädigungen an Geräten führen.



Zweipolig/Neutrale Sicherung

Achtung: Zweipolige bzw. Neutralleiter-Sicherung im Netzteil. Netzstecker ziehen, um sicherzustellen, daß keine Spannung am Gerät anliegt. Entfernen Sie alle Netzkabel vor dem Öffnen der Abdeckung dieses Produkts oder dem Berühren der Innenteile.



Mehrere Stromeingänge

Risiko eines Stromschlags und Stomgefahr. Alle Stromversorgungseinheiten sind unabhängig. Trennen Sie alle Stromversorgungen, um einen abgeschalteten Zustand im Inneren der Switch-Plattform sicherzustellen.



Bei Gewitter - Elektrische Gefahr

Arbeiten Sie während eines Gewitters und Blitzschlag nicht am Gerät, schließen Sie keine Kabel an oder ab.



Anschließen/Trennen von Kupferkabel

Kupferkabel sind schwer und nicht flexible. Deshalb müssen sie vorsichtig an die Anschlüsse angebracht bzw. davon getrennt werden. Lesen Sie die speziellen Warnungen und Anleitungen des Kabelherstellers.



Rack-Montage und Wartung

Wenn dieses Produkt in einem Rack montiert oder gewartet wird, sind besondere Vorsichtsmaßnahmen zu ergreifen, um die Stabilität des Systems zu gewährleisten. Im Allgemeinen sollten Sie das Gestell von unten nach oben mit Geräten füllen.



Geräteinstallation

Diese Gerät sollte nur von geschultem und qualifiziertem Personal installiert, ausgetauscht oder gewartet werden.



Geräteentsorgung

Die Entsorgung dieses Geräts sollte unter Beachtung aller nationalen Gesetze Bestimmungen erfolgen.



Regionale und nationale elektrische Bestimmungen

Dieses Gerät sollte unter Beachtung der regionalen und nationalen elektrischen Bestimmungen installiert werden.



Installationscodes

Dieses Gerät muss entsprechend der aktuellsten Version des National Electrical Code installiert werden. In Nordamerika muss das Gerät gemäß den geltenden Anforderungen des US National Electrical Code und des Canadian Electrical Code installiert werden.



Akkuaustausch

Warnung: Nur durch von UL anerkannten Akkus ersetzen, die für maximalen anormalen Ladestrom von nicht weniger als 4mA zertifiziert sind. Es besteht Explosionsgefahr, wenn der Akku durch einen Akku eines falschen Typs ersetzt wird. Akkus gemäß den Anweisungen entsorgen.



UL- und CSA-zertifiziertes Netzkabel

Für Nordamerika Stromanschluss, wählen Sie ein Netzkabel, das UL-und CSA Certified 3 - Leiter, [18 AWG], mit einem angespritztem Stecker bewertet bei 125 V, [15], mit einer Mindestlänge von 1,5 m [Six Feet] aber nicht mehr als 4,5 m.

Für die europäischen Zusammenhang, wählen Sie ein Netzkabel, das international harmonisiert und der Aufschrift "<HAR>", 3 - Leiter, mindestens 0,75 mm² Draht, bewertet mit 300 V, mit einem PVC-Mantel isoliert. Das Kabel muss eine angespritztem Stecker bewertet bei 250 V, 10 A.



Hoher Ableitstrom

WARNUNG: Hohe Ableitstrom; Earth Verbindung, bevor Sie die Verbindung von wesentlicher Bedeutung werden.



Installationscodes

Dieses Gerät muss installiert sein, entsprechend auf die neueste Version des Landes National Electrical Code. Für Nordamerika, müssen in Übereinstimmung mit den geltenden Vorschriften in der US-amerikanischen National Electrical Code und dem Canadian Electrical Code.



Verbindung der Geräte untereinander

Kabel für den Anschluss an das Gerät RS232-und Ethernet-Schnittstellen müssen UL zertifiziert Typ DP-1 oder DP-2. (Hinweis-, wenn nicht mit Wohnsitz in LPS-Schaltung)



Überstromschutz: Eine leicht zugängliche Auflistung Abzwegleitung Überstrom-Schutzeinrichtung 20 A bewertet werden müssen in dem Gebäude Verkabelung.

Warnung vor Geräuschpegel

Der im Abschnitt mit den technischen Daten aufgeführte Geräuschpegel stellt die nach ISO 7779 für den Sollzustand gemessenen Geräuschemissionen des Produkts dar. Der tatsächliche Lärmpegel kann je nach Installationsbedingungen variieren. Dazu gehören unter anderem, aber nicht ausschließlich, die Anzahl der Racks für die Installation, die Gesamtinstallationsgröße, das Rack- und anderes Ausrüstungsmaterial sowie Lärmpegel, Lüfterfehler, Raumtemperatur, Raumkonfiguration und der Mitarbeiterstandort in Bezug auf das Gerät. Der Eigentümer des Rechenzentrums sollte für einen wirksamen Lärmschutz gemäß OSHA-Standard sorgen, um Mitarbeiter vor übermäßiger und anhaltender Lärmbelastung zu schützen.



Switch nicht als Regal oder Arbeitsplatz nutzen

Achtung: Auf Schieber/Schienen montiertes Gerät ist nicht als Regal oder Arbeitsbereich zu nutzen. Die Schienen sind nicht dafür bestimmt, die Einheit aus dem Gestell weg zu ziehen. Sie sind nur für die permanente Installation an einem endgültigen Standort gedacht, nicht für Instandhaltung und Wartung.



WEEE-Direktive

Gemäß WEEE Directive 2002/96/EC müssen alle elektrischen und elektronischen Abfallgeräte (EEE) separat gesammelt und nicht mit normalem Haushaltsmüll entsorgt werden. Dieses Produkt und alle seine Teile in verantwortungsvoller und umweltfreundlicher Art und Weise entsorgen.

Advertencias de seguridad de instalación (Spanish)



Instrucciones de instalación

Antes de conectar el equipo a la fuente de alimentación, leer todas las instrucciones de instalación.



Lesión corporal a causa de peso

Recurra a suficientes personas para levantar este producto sin.

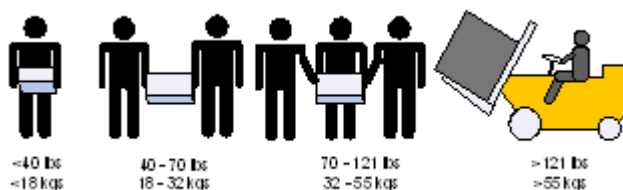

Equipos pesados

Dado que el equipo es pesado, se debe mover únicamente mediante un elevador mecánico, para evitar lesiones.



Riesgo de descarga eléctrica

Con el módulo del ventilador quitado, se obtiene acceso a las clavijas de alimentación desde dentro de la cavidad del módulo. NO introducir herramientas ni partes del cuerpo en la cavidad del módulo del ventilador.



Sobretemperatura

No se debe utilizar el equipo en un área con una temperatura ambiente superior a la máxima recomendada: 45°C. Además, para garantizar una circulación de aire adecuada, se debe dejar como mínimo un espacio de 8 cm (3 pulgadas) alrededor de las aberturas de ventilación.



Apilamiento del chasis

Los chasis no se deben apilar sobre otros equipos. La caída del chasis podría causar lesiones corporales, así como daños al equipo.



Conexión redundante de fuente de alimentación: peligro de descarga

Este producto incluye una fuente de alimentación redundante o, en su lugar, una vacía. Si se dispone de una fuente de alimentación vacía, no utilizar el producto si su tapa está quitada o no está bien cerrada.



Fusible neutro o de polo doble

Dos fusibles, uno en el polo y otro en el neutro. Quitar los cables de corriente antes de abrir la tapa de este producto o tocar cualquier componente interno.



Tomas de alimentación múltiples

Riesgo de descarga eléctrica y peligro de corriente. Todas las fuentes de alimentación son independientes. Desconecte todas las fuentes de alimentación, para asegurar que no haya corriente alguna dentro de la plataforma de conmutación.



Al haber rayos: peligro de descarga

No utilizar el equipo ni conectar o desconectar cables durante períodos de actividad de rayos.



La conexión y desconexión de cables de cobre

Dado que los cables de cobre son pesados y no son flexibles, su conexión a los conectores y su desconexión se deben efectuar con mucho cuidado. Para ver advertencias o instrucciones especiales, consultar al fabricante del cable.



Montaje y mantenimiento del bastidor

Al instalar o realizar el mantenimiento de este aparato en un bastidor, es preciso adoptar precauciones especiales para garantizar que el sistema se mantenga estable. En general, en un bastidor, los equipos se deben instalar comenzando desde abajo hacia arriba.



Instalación del equipo

La instalación, el reemplazo y el mantenimiento de este equipo estarán a cargo únicamente de personal capacitado y competente.



Eliminación del equipo

La eliminación definitiva de este equipo se debe efectuar conforme a todas las leyes y reglamentaciones nacionales.



Códigos eléctricos locales y nacionales

Este equipo se debe instalar conforme a los códigos eléctricos locales y nacionales.



Códigos de instalación

Este dispositivo se debe instalar conforme a la versión más reciente de los códigos eléctricos nacionales del país en cuestión. En América del Norte, el equipo se debe instalar de acuerdo con las disposiciones vigentes del Código Eléctrico Nacional de los EE.UU. y del Código Eléctrico de Canadá.



Cambio de batería

Il y a danger d'explosion s'il y a remplacement incorrect de la batterie. Remplacer uniquement avec une batterie du même type ou d'un type équivalent recommandé par le

constructeur. Mettre au rebut les batteries usagées conformément aux instructions du fabricant.



Cable de alimentación homologado por UL y con certificación CSA

En conexiones de América del Norte, seleccionar un cable de alimentación homologado por UL y con certificación CSA de tres conductores, [16 AWG], terminado en un enchufe moldeado con capuchón de 125 voltios nominal, [13 A], con una longitud mínima de 1,5 metros, pero no más de 4,5 metros.

En conexiones europeas, seleccionar un cable de alimentación armonizado internacionalmente y marcado "<HAR>", de tres conductores, hilo de 1,0 mm² como mínimo, 300 voltios nominal, con cobertura protectora aislante de PVC. El cable debe tener un enchufe moldeado con capuchón de 250 voltios nominal, 10 A.



Alta corriente de fuga

ADVERTENCIA: Alta corriente de fuga. Es esencial efectuar la conexión a tierra antes de conectar la alimentación.



Códigos de instalación

Este dispositivo se debe instalar conforme a la versión más reciente de los códigos eléctricos nacionales del país en cuestión. En América del Norte, el equipo se debe instalar de acuerdo con las disposiciones vigentes del Código Eléctrico Nacional de los EE.UU. y del Código Eléctrico de Canadá.



Interconexión de unidades

Los cables para la conexión con las interfaces RS232 y Ethernet de la unidad deben estar homologados por UL tipo DP-1 o DP-2. (Nota: cuando residen en circuito no de tipo LPS).



Protección contra sobrecargas: Al cableado del edificio se debe incorporar un dispositivo de protección contra sobrecargas de circuito derivado, de fácil acceso, con una corriente nominal de 20 A.

Advertencia de nivel acústico

El nivel acústico indicado en la sección Especificaciones representa el ruido del producto medido de acuerdo con la norma ISO 7779 en condiciones nominales. El nivel de ruido real puede variar en función de las condiciones de instalación, incluido pero no limitado al número de bastidores en la instalación, el tamaño general de la instalación, el rack y otros niveles de material y ruido del equipo, los fallos del ventilador, la temperatura ambiente, la configuración de la sala y la ubicación del empleado en relación con el equipo. El propietario del centro de datos debe gestionar la conservación efectiva de las audiciones según la norma OSHA para proteger a los empleados de la exposición prolongada al ruido.



No utilizar el conmutador como estante ni como espacio de trabajo

Cuidado: Equipos montados en deslizadores o rieles no se deben utilizar como estantes ni como espacio de trabajo. La finalidad de los rieles no es deslizar la unidad hacia afuera del bastidor. Sirven solo para la instalación permanente en el lugar de destino final, no para fines de servicio o mantenimiento



Directiva WEEE

Conforme a la Directiva 2002/96/CE sobre RAEE, todos los residuos de equipos eléctricos y electrónicos (EEE) se deben recolectar por separado y no se deben eliminar junto con residuos domésticos. Al deshacerse de este producto y de todas sus partes, hágalo de una manera responsable y respetuosa con el medio ambiente.

Предупреждения по технике безопасности при установке (Russian)



Инструкция по установке

Перед подключением оборудования к источнику питания следует ознакомиться с инструкцией по установке.



Травмы при переносе тяжелых предметов

Для поднятия этого изделия следует задействовать достаточное количество людей.

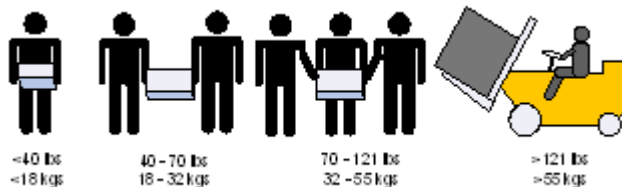

Тяжелое оборудование

Это тяжелое оборудование, поэтому его следует перемещать с помощью механического подъемника во избежание травм.



Опасность поражения электрическим током

Опасность поражения электрическим током! Когда снят вентиляторный модуль, существует возможность повреждения контактов питания в его углублении. НЕ вставлять инструменты или части тела в углубление вентиляторного модуля.



Перегрев

Не эксплуатировать это оборудование в помещении с температурой окружающей среды, превышающей максимально рекомендуемое значение: 45 °C (113 °F). Более того, для надлежащей вентиляции следует обеспечить зазор вокруг вентиляционных отверстий не менее 8 см (3 дюйма).



Установка шасси поверх другого оборудования

Не устанавливать шасси поверх другого оборудования. Падение шасси может привести к травмам и повреждению оборудования.



Опасность поражения электрическим током резервного источника питания

В этом изделии установлен резервный источник питания или модуль-заглушка. Если установлен модуль-заглушка, не эксплуатировать изделие со снятой или ненадежно закрепленной крышкой модуля-заглушки.



Двухполюсный предохранитель на фазном и нейтральном проводах

В этой системе установлен двухполюсный предохранитель на фазном и нейтральном проводах. Открывать кожух этого изделия или касаться внутренних деталей можно только после отсоединения всех шнуров питания.



Несколько источников питания

Опасность поражения электрическим током и опасные энергетические воздействия. Блоки питания независимы друг от друга. Чтобы обесточить все компоненты внутри платформы коммутации, следует отсоединить все блоки питания.



Опасность поражения электрическим током во время грозы

Во время грозы запрещается работать с оборудованием и подключать или отключать кабели.



Подсоединение и отсоединение медных кабелей

Медные кабели тяжелые и негибкие, поэтому следует осторожно их подсоединять и отсоединять. За особыми предупреждениями и указаниями следует обратиться к производителю кабеля.



Установка или обслуживание в стойке

При установке или обслуживании этого изделия в стойке следует обеспечить устойчивость системы. Как правило, стойка заполняется оборудованием снизу вверх.



Установка оборудования

Устанавливать, заменять и/или обслуживать это оборудование должен только подготовленный и квалифицированный персонал.



Утилизация оборудования

Это оборудование утилизируется в соответствии с национальными законами и постановлениями.



Местные и национальные правила установки электрооборудования

Это оборудование устанавливается в соответствии с местными и национальными правилами установки электрооборудования.



Правила установки электрооборудования

Это устройство устанавливается в соответствии с последним изданием национальных правил установки электрооборудования. В Северной Америке оборудование устанавливается в соответствии с действующими требованиями Национальных правил эксплуатации и обслуживания электрических установок США и Канады.



Замена аккумулятора

Осторожно! Заменять только аккумулятором, одобренным организацией UL и рассчитанным на максимальный аномальный зарядный ток не менее 4 мА. Существует риск взрыва при замене аккумулятора другим аккумулятором неправильного типа. Отработавшие аккумуляторы утилизируются в соответствии с указаниями.



Шнур питания, включенный в номенклатуру UL и сертифицированный Канадской ассоциацией стандартизации (CSA)

Подключение к электропитанию в Северной Америке выполняется с помощью шнура питания, включенного в номенклатуру UL и сертифицированного Канадской ассоциацией стандартизации (CSA), 3-жильного, [16 AWG], длиной от 1,5 м [6 футов] до 4,5 м, с литой вилкой, рассчитанной на 125 В [13 А].

Подключение к электропитанию в Европе выполняется с помощью гармонизированного шнура питания с маркировкой <HAR>, 3-жильного, с сечением жилы не менее 1,0 мм², рассчитанного на номинальное напряжение 300 В, с ПВХ оболочкой. Шнур должен иметь литую вилку, рассчитанную на 250 В, 10 А.



Высокий ток утечки

Осторожно! Высокий ток утечки. Заземлить перед подключением к электропитанию.



Правила установки электрооборудования

Это устройство устанавливается в соответствии с последним изданием национальных правил установки электрооборудования. В Северной Америке оборудование

устанавливается в соответствии с действующими требованиями Национальных правил эксплуатации и обслуживания электрических установок США и Канады.



Защита от перегрузки по току

Цепь подвода питания должна быть оборудована устройством защитного отключения от сети на ток 20А, которое находится в легкодоступном месте.



Подсоединение устройств

Для подключения к разъемам RS232 и Ethernet используются кабели типа DP-1 или DP-2, сертифицированные организацией UL. (Примечание. При подключении к сети без ограниченного источника электропитания).



Максимальная токовая защита. В проводку здания в легкодоступном месте следует включить устройство защиты от перегрузки по току номиналом 20 А.

Предупреждение об уровне шума

Уровень шума, указанный в разделе «Технические характеристики», представляет собой создаваемый изделием уровень шума, измеренный в соответствии со стандартом ISO 7779 в номинальных условиях. Фактический уровень шума может варьироваться в зависимости от условий установки, включая (но не ограниваясь этими данными) количество стоек в установке, общий размер установки, материалы, из которых изготовлены стойки и другое оборудование, уровни шума стоек, неисправности вентиляторов, температуру в помещении, конфигурацию помещения и расположение сотрудников относительно оборудования. Владелец дата-центра должен обеспечить эффективную защиту здоровья органов слуха в соответствии со стандартом OSHA и оградить сотрудников от чрезмерного и длительного воздействия шума.



Не использовать коммутатор как полку или рабочую поверхность

Внимание! Оборудование, установленное на направляющих, не должно использоваться как полка или рабочая поверхность. Направляющие не предназначены для удерживания устройства, выдвинутого из стойки. Они предназначены для стационарной установки только в конечном положении и не используются для обслуживания устройства.



Директива WEEE

В соответствии с Директивой 2002/96/EC (WEEE) отходы электрического и электронного оборудования должны собираться и утилизироваться отдельно от обычных бытовых отходов. Следует утилизировать это изделие и все его части ответственным и экологически безопасным способом.

Avertismente privind siguranța la instalare (Romanian)



Instrucțiuni de instalare

Citiți toate instrucțiunile de instalare înainte de a conecta.



Accidentare cauzată de greutate

Apelați la un număr suficient de persoane pentru a ridica în siguranță acest produs.

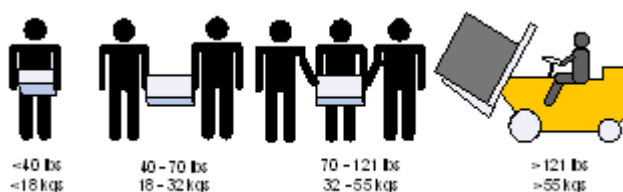

Echipament greu

Acest echipament este greu și trebuie să fie mutat folosind un dispozitiv mecanic de ridicare pentru a evita producerea de leziuni.



Risc de șoc electric

Odată ce modulul ventilator este îndepărtat, pinii electrici sunt accesibili în cavitatea modulului. NU introduceți instrumente sau părți din corp în cavitatea modulului ventilator.



Temperatură în exces

Acest echipament nu trebuie să fie acționat într-o zonă unde temperatura ambiantă depășește valoarea maximă recomandată: 45°C (113°F). În plus, pentru a asigura un flux de aer adecvat, lăsați un spațiu liber de cel puțin 8 cm (3 inchi) în jurul fantelor de ventilare.



Suprapunerea cadrului

Cadrul nu trebuie să fie suprapus peste niciun alt echipament. În cazul în care cadrul cade, poate cauza leziuni corporale și deteriorări ale echipamentului.



Conexiunea la o sursă de alimentare electrică suplimentară - pericol electric

Acest produs include o sursă de alimentare suplimentară sau un spațiu gol în locul acesteia. În cazul în care spațiul pentru sursa de alimentare este gol, nu operați produsul când capacul orb este îndepărtat sau nu este fixat în mod sigur.



Siguranță fuzibilă bipolară/neutră

Acest sistem este prevăzut cu siguranță fuzibilă bipolară/neutră. Îndepărtați toate cordonurile de alimentare înainte de a deschide capacul acestui produs sau înainte de a atinge orice componente interne.



Multiple mufe electrice

Risc de șoc electric și pericol electric. Toate aparatele cu alimentare de la rețea sunt independente. Deconectați toate sursele de alimentare cu energie pentru a asigura decuplarea în interiorul platformei de comutare.



În timpul descărcărilor electrice - pericol electric

În timpul perioadelor cu descărcări electrice luminoase, nu lucrați cu echipamentul sau nu conectați sau deconectați cablurile.



Conectarea/deconectarea cablului din cupru

Cablurile din cupru sunt grele și inflexibile, de aceea trebuie să fie atașate sau detașate de conectori cu grijă. Consultați producătorul de cabluri pentru avertismente/instrucțiuni speciale.



Montarea sau depanarea într-un rack

Când acest produs este montat sau depanat într-un rack, trebuie să fie luate măsuri de precauție speciale pentru a se asigura că sistemul rămâne stabil. În general, trebuie să umpleți rack-ul cu echipamente începând de jos în sus.



Instalarea echipamentului

Acest echipament trebuie să fie instalat, înlocuit și/sau depanat numai de către personal instruit și calificat.



Eliminarea echipamentului

Eliminarea acestui echipament trebuie să se realizeze în conformitate cu toate legile și regulamentele naționale.



Codurile electrice locale și naționale

Acest echipament trebuie să fie instalat conform codurilor electrice locale și naționale.



Codurile de instalare

Acest dispozitiv trebuie să fie instalat în conformitate cu ultima versiune a codurilor electrice naționale ale țării în cauză. Pentru America de Nord, echipamentul trebuie să fie instalat conform cerințelor aplicabile din Codul electric național al SUA și Codul electric canadian.



Înlocuirea bateriei

Avertisment: Înlocuiți numai cu o baterie recunoscută UL, certificată pentru curent de încărcare anormal maxim de minimum 4 mA

Există risc de explozie în cazul în care bateria este înlocuită cu o baterie necorespunzătoare. Eliminați bateriile folosite în conformitate cu instrucțiunile.



Cordon de alimentare electrică înregistrat UL și certificat CSA

Pentru conectarea la o sursă de alimentare pentru America de Nord, selectați un cordon de alimentare care este înregistrat UL și certificat CSA, cu 3 conductoare, [16 AWG], terminat cu o fișă turnată, cu putere nominală egală cu 125 V, [13 A], cu o lungime de minimum 1,5 m [șase picioare], dar nu mai lung de 4,5 m.

Pentru conectarea la o sursă de alimentare în Europa, selectați un cordon de alimentare care este armonizat la nivel internațional și marcat „<HAR>”, cu 3 conductoare, cu minimum 2 fire de 1,0 mm, cu putere nominală egală cu 300 V și cu o manta izolantă din PVC. Cordonul de alimentare trebuie să fie prevăzut cu o fișă turnată cu putere nominală egală cu 250 V, 10 A.



Curent de scurgere de înaltă frecvență

Avertisment: Curent de scurgere de înaltă frecvență; Împământarea este esențială înainte de a conecta sursa de alimentare.



Codurile de instalare

Acest dispozitiv trebuie să fie instalat în conformitate cu ultima versiune a codurilor electrice naționale ale țării în cauză. Pentru America de Nord, echipamentul trebuie să fie instalat conform cerințelor aplicabile din Codul electric național al SUA și Codul electric canadian.



Interconectarea unităților

Cablurile pentru conectarea la unitatea RS232 și la interfețele Ethernet trebuie să fie de tipul DP-1 sau DP-2 certificate UL. (Notă- când se regăsesc într-un circuit non-LPS).



Protecție la supracurent: Un dispozitiv de protecție la supracurent, înregistrat în circuitul de ramificare, ușor accesibil și cu o putere nominală egală cu 20 A trebuie să fie integrat în cablajul clădirii.

Avertizare privind nivelul acustic

Nivelul acustic menționat în secțiunea Specificației reprezintă zgomotul produsului, măsurat în conformitate cu standardul ISO 7779, în condiții nominale. Nivelul real de zgomot poate varia în funcție de condițiile de instalare, inclusiv, dar fără limitare, numărul de stive din configurație, dimensiunea generală a configurației, materialul de fabricație al stivelor și al

altor echipamente, precum și nivelurile de zgomot ale acestora, defectele ventilatoarelor, temperatura și designul încăperii, precum și poziția angajaților față de echipament. Proprietarul centrului de date trebuie să gestioneze eficient normele de protecție auditivă, conform standardului OSHA, pentru a proteja angajații împotriva expunerii prelungite la zgomot.



Nu utilizați comutatorul ca raft sau spațiu de lucru

Atenție: Echipamentul montat pe o linie de alunecare/șină nu va fi utilizat ca raft sau spațiu de lucru. Scopul șinelor nu este de a glisa unitatea de pe rack. Acestea sunt destinate instalării permanente numai la punctul final de oprire și nu vor fi folosite pentru depanare și întreținere



Directiva DEEE

În conformitate cu Directiva DEEE 2002/96/CE, toate deșeurile de echipamente electrice și electronice (EEE) trebuie colectate separat și nu trebuie eliminate împreună cu deșeurile menajere obișnuite. Eliminați acest produs și toate componentele sale în mod responsabil și ecologic.



Restricții electrice pentru Norvegia

This unit is intended for connection to a TN power system and an IT power system of Norway only.

Sigurnosna upozorenja za instaliranje (Croatian)



Upute za instaliranje

Pažljivo pročitajte upute za instaliranje prije spajanja opreme na izvor električne energije.



Tjelesne ozljede uslijed težine

Kako biste sigurno podignuli ovaj proizvod, koristite dovoljan broj ljudi.

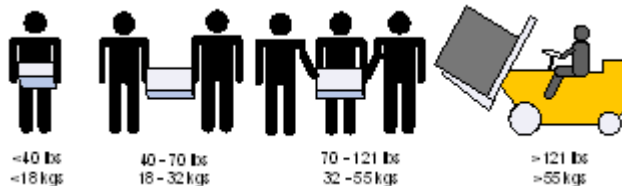

Teška oprema

Ova oprema je vrlo teška i treba se premještati pomoću mehaničkog dizala kako bi se izbjegle ozljede.



Rizik od strujnog udara!

Rizik od strujnog udara! S uklonjenim modulom ventilatora, perima napajanja se može pristupiti u otvoru modula. NEMOJTE umetati alat ili dijelove tijela u otvor modula ventilatora.



Pregrijavanje

Ovom se opremom ne bi trebalo rukovati u područjima s temperaturom okoline koja premašuje najviše preporučene vrijednosti: 45°C (113°F). Osim toga, kako bi se osigurao odgovarajući protok zraka, omogućite najmanje 8 cm (3 inča) razmaka oko otvora ventilatora.



Slaganje kućišta

Kućište se ne bi trebalo slagati na drugu opremu. Ako kućište padne, može izazvati tjelesne ozljede i oštećenje opreme.



Redundantno napajanje - Opasnost od električne energije

Ovaj proizvod uključuje redundantno napajanje ili prazan prostor na njegovu mjestu. U slučaju praznog prostora za napajanje, nemojte rukovati proizvodom ako je poklopac uklonjen ili ako nije dobro pričvršćen.



Dvopolni/neutralni osigurači

Ovaj sustav raspolaže dvopolnim/neutralnim osiguračima. Uklonite sve kabele napajanja prije otvaranja poklopca proizvoda ili dodirivanja unutarnjih dijelova.



Višestruki ulazi za napajanje

Rizik od strujnog udara i opasnost od električne energije. PSU jedinice su neovisne. Odspojite sva napajanja kako biste osigurali stanje bez napajanja unutar platforme preklopnika.



Tijekom udara munje - Opasnost od električne energije

Tijekom djelovanja munja, nemojte raditi na opremi ili spajati ili odspajati kabele.



Spajanje/Odspajanje bakrenog kabela

Bakreni kabeli su teški i nesavjetljivi i kao takvi se moraju pažljivo priključiti na ili isključiti iz konektora. Obratite se proizvođaču kabela za posebna upozorenja/upute.



Montaža ormarića i servisiranje

Kad se proizvod montira ili se servisira u ormariću, moraju se poduzeti posebne mjere opreza kako bi se osiguralo da sustav ostane stabilan. Općenito, trebali biste ispunjavati ormarić s opremom počevši od dna prema vrhu.



Instaliranje opreme

Ovu bi opremu trebalo instalirati, zamjenjivati i/ili servisirati samo obučeno i kvalificirano osoblje.



Odlaganje opreme

Odlaganje opreme trebalo bi se vršiti sukladno nacionalnim zakonima i propisima.



Lokalni i nacionalni električni kodovi

Ova oprema trebala bi se instalirati u skladu s lokalnim i nacionalnim električnim kodovima.



Instalacijski kodovi

Ovaj se uređaj mora instalirati sukladno najnovijoj verziji nacionalnih električnih kodova države. U Sjevernoj Americi oprema se mora instalirati sukladno važećim zahtjevima navedenim u US National Electrical Code i Canadian Electrical Code.



Zamjena baterije

Upozorenje: Bateriju zamijenite samo baterijom iz serije UL koja je certificirana za maksimalnu nepravilnu struju punjenja ne manju od 4 mA
Postoji rizik od eksplozije ako se baterija zamijeni neodgovarajućom vrstom. Odložite prazne baterije sukladno uputama.



UL CSA kabel napajanja

Za sjevernoameričku mrežu odaberite kabel napajanja koji je na UL listi i sa CSA certifikatom, 3 - žilni, [16 AWG] (16 AWG) koji završava lijevanim utikačem nazivnog napona od 125 V, [13 A], minimalne duljine od 1,5 m [six feet] (šest stopa), ali ne dulji od 4,5 m.

Za europsku mrežu odaberite kabel napajanja koji je međunarodno usklađen i označen "<HAR>", 3 - žilni, s najmanje 1,0 mm² žice, nazivnog napona od 300 V, s PVC izolacijom. Kabel mora imati lijevani utikač nazivnog napona od 250 V, nazivne struje od 10 A.



Veliko curenje struje

Upozorenje: Veliko curenje struje; Prije spajanja napajanja nužno je spojiti uzemljenje.



Instalacijski kodovi

Ovaj se uređaj mora instalirati sukladno najnovijoj verziji nacionalnih električnih kodova države. U Sjevernoj Americi oprema se mora instalirati sukladno važećim zahtjevima navedenim u US National Electrical Code i Canadian Electrical Code.



Interkonekcija uređaja

Kabli za spajanje na jedinicu RS232 i Ethernet sučelja moraju biti s UL certifikatom vrste DP-1 ili DP-2. (Napomena - kad se nalazi u krugu bez LPS vodiča).



Zaštita od strujnog preopterećenja: Uvijek dostupni odobreni zaštitni uređaji od strujnog preopterećenja nazivne struje od 20 A moraju se ugraditi u ožičenje zgrade.

Upozorenje na akustičnu razinu

Akustična razina navedena u odjeljku Specifikacije predstavlja buku proizvoda izmjerenu u skladu s ISO 7779 pod nominalnim uvjetima. Stvarna razina buke može varirati ovisno o uvjetima instalacije, uključujući, ali ne ograničavajući se na broj stalaka u instalaciji, ukupnu veličinu instalacije, materijal stalka i druge opreme i razine buke, kvar ventilatora, sobnu temperaturu, raspored prostorija i položaj zaposlenika u odnosu na opremu. Vlasnik podatkovnog centra trebao bi upravljati učinkovitim očuvanjem sluha prema standardu OSHA kako bi zaštitio zaposlenike od prekomjerne i produžene izloženosti buci.



Nemojte koristiti preklopnik kao policu ili radnu površinu

Pozor: Oprema montirana na klizače/vodilice ne bi se trebala koristiti kao polica ili radna površina. Vodilice nisu namijenjene za povlačenje uređaja iz ormarića. Služe samo za trajnu instalaciju na konačnom položaju, a ne za servisiranje i održavanje.



WEEE direktiva

Sukladno WEEE direktivi 2002/96/EZ, sav električni i elektronički otpad (EEE) trebao bi se prikupljati zasebno i ne bi se trebao odlagati kao običan kućanski otpad. Odlaganje ovog proizvoda i svih njegovih dijelova vršite na odgovoran i ekološki način.



Električna ograničenja države Norveške

Ovaj je uređaj namijenjen samo za spajanje na električni sustav s TN uzemljenjem i na električni sustav s IT uzemljenjem države Norveške.

Avvertenze di sicurezza per l'installazione (Italian)



Istruzioni di installazione

Leggere tutte le istruzioni di installazione prima di collegare l'apparecchiatura all'alimentazione.



Lesioni a causa del peso

Usare un numero di persone sufficiente per sollevare in sicurezza questo prodotto.

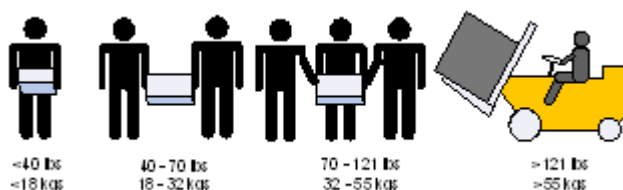

Apparecchiatura pesante

Questa apparecchiatura è molto pesante e va spostata mediante un sollevatore meccanico, per evitare lesioni.



Rischio di scosse elettriche!

Con il modulo ventola rimosso, i pin di alimentazione sono accessibili all'interno della cavità del modulo. NON inserire strumenti o parti del corpo nella cavità del modulo della ventola.



Temperatura eccessiva

Questa apparecchiatura non va utilizzata in un'area con una temperatura ambiente superiore a quella massima consigliata: 45 °C (113 °F). Inoltre, per assicurare un flusso d'aria adeguato, lasciare almeno 8 cm (3 pollici) di spazio attorno alle aperture di ventilazione.



Impilare lo chassis

Kućište se ne bi trebalo slagati na drugu opremu. Ako kućište padne, može izazvati tjelesne ozljede i oštećenje opreme.



Collegamento di alimentazione ridondante - Pericoli elettrici

Questo prodotto è dotato di un alimentatore ridondante o, qualora esso non sia installato, di uno spazio vuoto. Qualora l'alimentatore non sia installato, non utilizzare il prodotto con il coperchio rimosso o non fissato correttamente.



Fusibili fase/neutro

Questo sistema dispone di fusibili fase/neutro. Rimuovere tutti i cavi di alimentazione prima di aprire il coperchio di questo prodotto o di toccare parti interne.



Prese di alimentazione multiple

Rischio e pericolo di scosse elettriche. Gli alimentatori sono tutti indipendenti. Scollegare tutti gli alimentatori per assicurarsi che il commutatore non sia sotto tensione



Durante i temporali, pericolo di scosse elettriche

Durante i temporali, non effettuare interventi sull'apparecchiatura e non collegare o scollegare i cavi.



Collegamento/scollegamento del cavo di rame

I cavi di rame sono pesanti e non flessibili. Di conseguenza, vanno collegati o scollegati con cura dai connettori. Per avvertenze/istruzioni speciali, rivolgersi al produttore di cavi.



Montaggio su rack e manutenzione

Quando questo prodotto viene montato o sottoposto a manutenzione su un rack, è necessario adottare delle precauzioni speciali per assicurarsi che il sistema resti stabile. In generale, il rack va riempito con apparecchiature, procedendo dal basso verso l'alto.



Installazione dell'apparecchiatura

Questa apparecchiatura va installata, sostituita e/o sottoposta a manutenzione solo da personale addestrato e qualificato.



Smaltimento dell'apparecchiatura

Lo smaltimento di questa apparecchiatura va effettuato in conformità con tutte le leggi e le normative nazionali.



Codici elettrici locali e nazionali

Questa apparecchiatura va installata in conformità con le norme elettriche locali e nazionali.



Codici di installazione

Questo dispositivo va installato in conformità con l'ultima versione dei codici elettrici nazionali del Paese. Per il Nord America, l'apparecchiatura va installata in conformità con i requisiti applicabili del "codice elettrico nazionale USA" e del "codice elettrico canadese".



Sostituzione della batteria

Avvertenza: Sostituire solo con una batteria UL, certificata per accettare una corrente di ricarica anomala massima non inferiore a 4 mA. Se la batteria non viene sostituita con una batteria di tipo corretto, vi è il rischio di esplosione. Smaltire le batterie usate in conformità con le istruzioni.



Cavo di alimentazione UL e munito di certificazione CSA

Per una connessione di alimentazione nordamericana, selezionare un cavo di alimentazione di tipo UL e munito di certificazione CSA, a 3 conduttori, [16 AWG], terminato con una spina stampata con tensione nominale pari a 125 V, [13 A], di lunghezza minima pari a 1,5 m [sei piedi] ma non più lunga di 4,5 m. Per una connessione europea, selezionare un cavo di alimentazione armonizzato a livello internazionale e contrassegnato da “<HAR>”, a 3 conduttori, minimo 1,0 mm² fili, con guaina isolante in PVC. Il cavo deve disporre di una spina stampata di potenza nominale pari a 250 V, 10 A.



Corrente di dispersione elevata

Avvertenza: corrente di dispersione elevata; il collegamento a terra è essenziale prima di collegare l'alimentazione.



Codici di installazioni

Questo dispositivo va installato in conformità con l'ultima versione dei codici elettrici nazionali del Paese. Per il Nord America, l'apparecchiatura va installata in conformità con i requisiti applicabili del “codice elettrico nazionale USA” e del “codice elettrico canadese”.



Interconnessione delle unità

I cavi per il collegamento all'unità RS232 e alle interfacce Ethernet devono disporre della certificazione UL ed essere del tipo DP-1 o DP-2. (Nota: in caso di installazione su un circuito la cui potenza non è limitata).



Protezione contro le sovracorrenti: la cablatura dell'edificio deve integrare un dispositivo di protezione contro le sovracorrenti di potenza nominale pari a 20.

Avviso sul livello acustico

Il livello acustico indicato nella sezione Specifiche rappresenta il rumore del prodotto misurato in conformità allo standard ISO 7779 in condizioni nominali. Il livello di rumore effettivo può variare a seconda delle condizioni di installazione, tra cui, in via esemplificativa, il numero di rack nell'installazione, le dimensioni complessive dell'installazione, il materiale del rack e di altre apparecchiature e i livelli di rumore, i difetti delle ventole, la temperatura ambientale, la configurazione della stanza e la posizione del personale rispetto all'apparecchiatura. Il proprietario del data center dovrebbe adottare misure efficaci di protezione dell'udito secondo lo standard OSHA per tutelare i dipendenti dalla sovraesposizione al rumore.



Non utilizzare lo switch come scaffale o piano di lavoro

Attenzione: un'apparecchiatura scorrevole o montata su binari non va utilizzata come scaffale o piano di lavoro. I binari non sono progettati per far scorrere e allontanare l'unità dal rack. Essi sono destinati all'installazione permanente solo nel luogo di lavoro e non vengono utilizzati per assistenza e manutenzione



Direttiva RAEE

Secondo la direttiva RAEE 2002/96/EC, tutti i rifiuti da apparecchiature elettriche ed elettroniche (RAEE) vanno raccolti separatamente e non smaltiti nei normali rifiuti domestici. Smaltire questo prodotto e tutte le sue parti in modo responsabile e rispettoso dell'ambiente



Limitazioni relative all'alimentazione per la Norvegia

Questa apparecchiatura è progettata esclusivamente per il collegamento a un sistema di alimentazione TN e a un sistema di alimentazione IT.

Montaj Güvenlik Uyarıları (Turkish)



Montaj Talimatları

Ekipmanı güç kaynağına bağlamadan önce tüm montaj talimatlarını okuyun.



Ağırlık Nedeniyle Fiziksel Yaralanma

Bu ürünü güvenli bir şekilde kaldırmak için yeterli sayıda insandan yardım alın.

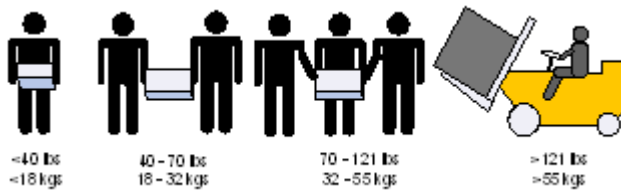

Ağır Ekipman

Bu ekipman çok ağırdır ve yaralanmaları önlemek için ekipmanın mekanik asansör kullanılarak taşınması gerekir.



Elektrik Çarpması Riski!

Fan modülüyle çıkarılan güç pimlerine modül boşluğu içinde erişilebilir. Fan modülü boşluğuna alet veya gövde parçaları yerleştirmeyin.



Aşırı ısınma

Bu ekipman, önerilen maksimum ortam sıcaklığını aşan alanlarda çalıştırılmamalıdır: 45 °C (113 °F). Ayrıca, düzgün hava akışı sağlamak için havalandırma deliklerinin etrafında en az 8 cm (3 inç) açıklık bırakılmalıdır.



Şasi İstif

Şasinin diğer herhangi bir ekipmanın üzerine istiflenmemesi gerekir. Şasi düşerse, fiziksel yaralanmalara ve ekipmanda hasara neden olabilir.



Yedekli Güç Kaynağı Bağlantısı -Elektrik Çarpma Tehlikesi

Bu ürün, yedekli güç kaynağı veya onun yerine boş elektrik kutusu içerir. Güç kaynağı için boş elektrik kutusu varsa, kutunun kapağı açıkken veya tam olarak kapatılmamışken ürünü çalıştırmayın.



Çift Kutuplu/Nötr Kesmeli Sigorta

Bu sistemde çift kutuplu/nötr kesmeli sigorta kullanılmaktadır. Ürünün kapağını açmadan veya herhangi bir iç parçaya dokunmadan önce bütün güç kablolarını çıkartın.



Çoklu Güç Girişleri

Elektrik çarpması riski ve enerji tehlikesi. Bütün PSU'lar (Güç Kaynağı Üniteleri) ayrıdır. Anahtar platformundaki gücü kapatmak için tüm güç kaynaklarının bağlantılarını kesin.



Şimşek - Elektrik Çarpma Tehlikesi

Gökyüzünde şimşek çaktığı zamanlarda, ekipman üzerinde çalışmayın veya kablo bağlamayın ya da kablo bağlantısı kesmeyin.



İskele Montajı ve Bakım

Bu ürün bir iskelede monte edildiye veya bir iskele ile sunulduysa, sistemin sabit kalması için özel önlemler alınmalıdır. Genelde, ekipmanları iskeleye aşağıdan yukarı doğru doldurmanız gerekir.



Ekipman Montajı

Ekipmanın yalnızca eğitimli ve nitelikli personel tarafından monte edilmesi, değiştirilmesi ve/veya bakımının yapılması gerekir.



Ekipmanın Atılması

Bu ekipmanın imhasında tüm ulusal yasalara ve düzenlemelere uyulması gerekir.



Yerel ve Ulusal Elektrik Kodları

Bu ekipmanın montajında yerel ve ulusal elektrik kodlarına uyulması gerekir.



Montaj Kodları

Bu cihazın, ülke ulusal elektrik kodlarının son sürümüne göre monte edilmesi gerekir. Kuzey Amerika için, ekipmanın ABD Ulusal Elektrik Kodu ve Kanada Elektrik Kodu'nun uygulama koşullarına göre monte edilmesi gerekir.



Pilin Değiştirilmesi

Uyarı: Yalnızca, maksimum düzgüsz şarj akımı 4mA'dan az olmayan, UL Onaylı pillerle değiştirin. Yanlış pil türü ile değiştirildiğinde patlama tehlikesi bulunmaktadır. Kullanılmış pillerden talimatlara uygun bir şekilde kurtulun.



UL Kayıtlı ve CSA Onaylı Güç Kaynağı Kablosu

Kuzey Amerika'da güç bağlantısı için, UL Kayıtlı ve CSA Onaylı bir güç kaynağı kablosu seçin, 3 - iletken, [16 AWG], 125 V değerinde, kalıplanmış bir fişle biten, [13 A], en az 1,5 m (altı fit) uzunluğunda fakat 4,5 m'den uzun olmayan bir kablo. Avrupa'da güç bağlantısı için, uluslararası uyumlu ve "<HAR>" işaretli, 3 - iletken, en az 1,0 mm² tel, 300 V değerinde ve PVC yalıtımlı bir güç kaynağı kablosu seçin. Kablonun 250 V, 10 A değerinde bir kalıplanmış fişi olması gerekmektedir.



Yüksek Kaçak Akım

Yüksek kaçak akım varsa; güç kaynağına bağlanmadan önce mutlaka topraklama bağlantısı yapılmalıdır.



Montaj Kodları

Bu cihazın, ülke ulusal elektrik kodlarının son sürümüne göre monte edilmesi gerekir. Kuzey Amerika için, ekipmanın ABD Ulusal Elektrik Kodu ve Kanada Elektrik Kodu'nun uygulama koşullarına göre monte edilmesi gerekir.



Ünitelerin Ara Bağlantısı

RS232 ünitesini ve Ethernet Arabirimlerini bağlayacak olan kabloların UL onaylı DP-1 veya DP-2 tipi olması gerekir. (Not- LPS olmayan devreye aitse).



Aşırı Akım Koruması: Kolayca erişilebilecek 20 V Kayıtlı devre parçası aşırı akım koruma cihazının bina elektrik şebekesinde kurulu olması gerekir.

Akustik Seviye Uyarısı

Teknik Özellikler bölümünde listelenen akustik seviye, nominal koşullarda ISO 7779 uyarınca ölçülen ürün gürültüsünü temsil eder. Gerçek gürültü seviyesi; kurulumdaki raf sayısı, toplam kurulum boyutu, raf ve diğer ekipman malzemesi ve gürültü düzeyleri, fan arızaları, oda sıcaklığı, oda yapılandırması ve ekipmanla ilgili olarak çalışan konumu dahil ancak bunlarla sınırlı olmamak üzere kurulum koşullarına bağlı olarak değişebilir. Veri merkezi sahibi, çalışanları gürültüye uzun süreli ve aşırı maruz kalmaya karşı korumak için OSHA standardına göre etkili bir işitme koruması yönetimi sağlamalıdır.



Anahtarı Raf veya Çalışma Alanı olarak kullanmayın!

Dikkat: Sürgülü/raylı ekipman raf veya çalışma alanı olarak kullanılamaz. Raylar üniteyi iskeleden uzağa kaydırmak için yapılmamıştır. Sadece, ekipmanın son olarak duracağı yerdeki kalıcı montaj içindir, servis veya bakım için kullanılamaz.



WEEE Yönergesi

WEEE Yönergesi 2002/96/EC uyarınca, tüm elektrikli ve elektronik ekipman atıkları (EEE) ayrı olarak toplanmalı ve evsel atıklarla birlikte çöpe atılmamalıdır. Bu ürün ve tüm parçaları çevreye dost ve sorumlu bir şekilde imha edilmelidir.



Norveç Güç Kısıtlamaları

Bu ünite, bir TN güç sistemine ve sadece Norveç'in IT güç sistemine bağlanmak içindir.

Japan VCCI Statement

この装置は、クラス A 情報技術装置です。この装置を家庭環境で使用すると電波妨害を引き起こすことがあります。この場合には使用者が適切な対策を講ずるよう要求されることがあります。 VCCI-A

(Hebrew) הוראות בטיחות בהתקנה

הוראות התקנה

קרא היטב את כל הוראות ההתקנה לפני חיבור המוצר לחשמל.

תקן ישראלי 

יש להתקין את המוצר תוך הקפדה על תקנות החשמל הנהוגות בישראל, ולעשות שימוש ביחידת חלוקת כוח העומדת בתקן ישראל (ת"י) 32

חבלת גוף כתוצאה מנשיאת משקל יתר 

נדרשת נוכחותם של מספר מתקינים כדי להרים את המוצר בבטחה.

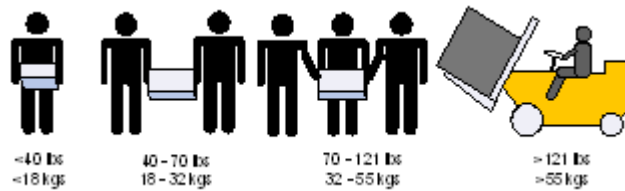

ציוד כבד 

המוצר כבד, ויש לשנעו באמצעות מעלית מכאנית כדי למנוע חבלה.

סכנת התחשמלות! 

סכנת התחשמלות! בעת שיחידת המאוורר מפורקת, רכיבי חשמל נחשפים בחלל הריק. אין להחדיר כלים או איברי גוף לחלל המיועד להרכבת היחידה

התחממות יתר 

אין להפעיל את המוצר באיזור שבו טמפרטורת החדר עולה על הטמפרטורה המקסימלית: 45°C (113°F). המומלצת בנוסף, כדי להבטיח כניסת אוויר תקינה, יש לוודא כי קיים שטח פנוי של 8 ס"מ (3 אינץ') לפחות סביב פתחי האוורור

ערימת המערכת 

אין לערום את המערכת על גבי ציוד אחר. במקרה של נפילה, עשויים להגרם נזקי גוף ורכוש.

חיבור ספק כוח נוסף - סכנת התחשמ 

המערכת מכילה ספק כוח נוסף לגיבוי, או, בחלק מהמקרים, חלל ריק המאפשר הרכבת ספק כזה. אין לעשות שימוש במערכת כשהמכסה החוסם את החלל הריק אינו סגור כהלכה

מספר שקעים חשמליים 

סכנת התחשמלות ואזהרת אנרגיה.
כל אחד מספקי הכוח פועל באופן עצמאי. יש לנתק את כל ספקי הכוח, כדי להבטיח ניתוק מוחלט של המערכת.
מזרם חשמלי



בעת סופות ברקים - סכנת התחשמלות!

בעת סופות ברקים, אין להפעיל את המערכת או לחבר/לנתק כבלים.



חיבור או ניתוק של כבלי נחושת

כבלי נחושת הם כבדים וקשיחים. לפיכך, יש לחברם ולנתקם מהמחברים בזהירות רבה. לאזהרות נוספות, יש לעיין בעלון לצרכן מטעם יצרן הכבלים



הרכבה על גבי מדף בארון

כאשר מרכיבים מוצר זה על גבי מדף בארון, יש לנקוט באמצעי זהירות מיוחדים בכדי להבטיח שיוותר יציב.. ככלל, יש להתחיל למלא את הארון מהמדף התחתון, ולהתקדם כלפי מעלה



התקנת המוצר

כל התקנה, החלפה או טיפול במוצר זה חייבות להתבצע על ידי איש צוות מיומן ומוסמך בלבד.



השלכה לאשפה בתום השימוש

השלכת המוצר בתום השימוש חייבת להיעשות בהתאם לכל התקנות והחוקים המקומיים.



תקנות חשמל מקומיות

יש להתקין מערכת זו בהתאם לתקנות החשמל המקומיות.



כבל אספקת חשמל

על מנת לחבר את המוצר לחשמל בצפון אמריקה, יש לבחור כבל חשמלי ובעל הסמכת CSA, מוליך - 3 [16 AWG],
שבקצהו תקע מובנה 125V, 13A.

אורכו המינימלי 1.5 מטר (6 אינץ') ואורכו המקסימלי 4.5 מטר.

לחיבור אירופאי, בחר כבל חשמלי בעל התאמה בינלאומית וסימון
"3-HAR", מוליך -3, גידים פנימיים באורך מינימלי של 1.0 מילימטר²
300V

עם עטיפת PVC מבודדת.
על הכבל לכלול תקע מובנה 250V, 10A.



תקנות התקנה

יש להתקין מערכת זו על פי הגרסה האחרונה של תקנות החשמל המקומיות הנהוגות במדינה. עבור צפון אמריקה, יש להתקין את המערכת בהתאם לתקנות החשמל הלאומיות המיושמות בארה"ב ובקנדה

חיבור בין מערכות 

על כבלים לחיבור היחידה לממשקי RS232 ו-Ethernet להיות בעלי הסמכת UL מסוג DP-2 או DP-1 (כאשר הם מצויים במעגל חשמלי שאינו מקור כוח מוגבל).

הגנה מפני מתח גבוה 

יש להקפיד על המצאותם בבניין ועל זמינותם של אמצעים להגנה מפני מתח גבוה בתקן 20A.

אזהרת עוצמה אקוסטית

רמת העוצמה האקוסטית המצוינת בפרק המפרטים מתייחסת לרעש מוצר שנמדד בהתאם לתקן ISO 7779 בתנאים נומינליים. רמת הרעש בפועל עשויה להשתנות בהתאם לתנאי ההתקנה, הכוללים אך לא מוגבלים למספר הכונניות בהתקנה, היקף ההתקנה הכולל, החומרים שמהם עשויות הכונניות ועשוי שאר הציוד, וכן רמות רעש, תקלות מאוורר, טמפרטורת ותצורת החדר ומיקום העובד ביחס לציוד. על האחראי על מרכז הנתונים להנהיג מדיניות יעילה של הגנה על שמיעת העובדים בהתאם לתקן OSHA, וזאת כדי להגן עליהם מפני חשיפה מוגזמת וממושכת לרעש.

אין להשתמש במערכת כמדף או כשטח עבודה 

זהירות: אין להשתמש בציוד כמדף או כשטח עבודה. המסילות לא נועדו לשליפת המערכת מהארון, אלא להתקנת המערכת במיקומה הקבוע והסופי בארון

תקנת WEEE 

על פי תקנות WEEE 2002/96/EC, יש להשליך את כל פסולת הציוד החשמלי והאלקטרוני בנפרד מפסולת ביתית רגילה. בתום השימוש, השלך לאשפה את המוצר הזה ואת כל חלקיו באופן אחראי וידידותי לסביבה

מגבלות חשמליות בנורבגיה 

בנורבגיה בלבד, יחידה זו מיועדת לחיבור למערכת אספקת חשמל מסוג TN, ולמערכת אספקת חשמל מסוג IT.

Document Revision History

Date	Revision	Description
August 2022	2.6	Updated OPNs in: <ul style="list-style-type: none"> • Ordering Information • Static Rail Kit • Telescopic Rail Kit • Accessory and Replacement Parts
August 2021	2.5	Updated: <ul style="list-style-type: none"> • Software Management
February 2021	2.4	Updated: <ul style="list-style-type: none"> • Troubleshooting
January 2021	2.3	Added the SB7880 OPNs to the Ordering Information .
March 2020	2.2	Updated: <ul style="list-style-type: none"> • Cable Installation - Added a link to the Mellanox Cable Management Guidelines and FAQ • Thermal Threshold Definitions • LED Notifications
February 2020	2.1	Added a warning under "System Installation and Initialization in " Installation "
January 2020	2.0	Added warnings to: <ol style="list-style-type: none"> 1. Interfaces under "I2C/Console (RS232)" 2. Interfaces Specifications under "RJ-45 CONSOLE and I²C Interface"
Oct. 2019	1.9	Modified latency on Introduction page to indicate 90ns instead of 100ns.
Dec. 2018		Migrated to on-line format; minor reorganization.
May 2017	1.8	Updated " Unit Identification LED "
Feb. 2017	1.7	Updated "RJ45 to DB9 Harness Pinout" Updated "Specifications"
Dec. 2016	1.6	Updated document title
Sept. 2016	1.5	Added "Noise Level" to "Specifications"
July 2016	1.4	Added the SB7780 InfiniBand router Updated LED colors in "Interfaces" Updated "Specifications"
Mar. 2016	1.3	Added SB7800 and SB7890 Updated "System Bring-Up of Managed Systems" Updated "Specifications"
July 2015	1.2	Changed document's title

Date	Revision	Description
June 2015	1.1	Added: Hebrew safety warnings Updated: <ul style="list-style-type: none"> • “SB77X0/SB78X0 Front Side View” • “SB77X0/SB78X0 Specifications”
Apr. 2015	1.0	Initial release

Notice

This document is provided for information purposes only and shall not be regarded as a warranty of a certain functionality, condition, or quality of a product. Neither NVIDIA Corporation nor any of its direct or indirect subsidiaries and affiliates (collectively: "NVIDIA") make any representations or warranties, expressed or implied, as to the accuracy or completeness of the information contained in this document and assumes no responsibility for any errors contained herein. NVIDIA shall have no liability for the consequences or use of such information or for any infringement of patents or other rights of third parties that may result from its use. This document is not a commitment to develop, release, or deliver any Material (defined below), code, or functionality.

NVIDIA reserves the right to make corrections, modifications, enhancements, improvements, and any other changes to this document, at any time without notice.

Customer should obtain the latest relevant information before placing orders and should verify that such information is current and complete.

NVIDIA products are sold subject to the NVIDIA standard terms and conditions of sale supplied at the time of order acknowledgement, unless otherwise agreed in an individual sales agreement signed by authorized representatives of NVIDIA and customer ("Terms of Sale"). NVIDIA hereby expressly objects to applying any customer general terms and conditions with regards to the purchase of the NVIDIA product referenced in this document. No contractual obligations are formed either directly or indirectly by this document.

NVIDIA products are not designed, authorized, or warranted to be suitable for use in medical, military, aircraft, space, or life support equipment, nor in applications where failure or malfunction of the NVIDIA product can reasonably be expected to result in personal injury, death, or property or environmental damage. NVIDIA accepts no liability for inclusion and/or use of NVIDIA products in such equipment or applications and therefore such inclusion and/or use is at customer's own risk.

NVIDIA makes no representation or warranty that products based on this document will be suitable for any specified use. Testing of all parameters of each product is not necessarily performed by NVIDIA. It is customer's sole responsibility to evaluate and determine the applicability of any information contained in this document, ensure the product is suitable and fit for the application planned by customer, and perform the necessary testing for the application in order to avoid a default of the application or the product. Weaknesses in customer's product designs may affect the quality and reliability of the NVIDIA product and may result in additional or different conditions and/or requirements beyond those contained in this document. NVIDIA accepts no liability related to any default, damage, costs, or problem which may be based on or attributable to: (i) the use of the NVIDIA product in any manner that is contrary to this document or (ii) customer product designs.

No license, either expressed or implied, is granted under any NVIDIA patent right, copyright, or other NVIDIA intellectual property right under this document. Information published by NVIDIA regarding third-party products or services does not constitute a license from NVIDIA to use such products or services or a warranty or endorsement thereof. Use of such information may require a license from a third party under the patents or other intellectual property rights of the third party, or a license from NVIDIA under the patents or other intellectual property rights of NVIDIA.

Reproduction of information in this document is permissible only if approved in advance by NVIDIA in writing, reproduced without alteration and in full compliance with all applicable export laws and regulations, and accompanied by all associated conditions, limitations, and notices.

THIS DOCUMENT AND ALL NVIDIA DESIGN SPECIFICATIONS, REFERENCE BOARDS, FILES, DRAWINGS, DIAGNOSTICS, LISTS, AND OTHER DOCUMENTS (TOGETHER AND SEPARATELY, "MATERIALS") ARE BEING PROVIDED "AS IS." NVIDIA MAKES NO WARRANTIES, EXPRESSED, IMPLIED, STATUTORY, OR OTHERWISE WITH RESPECT TO THE MATERIALS, AND EXPRESSLY DISCLAIMS ALL IMPLIED WARRANTIES OF NONINFRINGEMENT, MERCHANTABILITY, AND FITNESS FOR A PARTICULAR PURPOSE. TO THE EXTENT NOT PROHIBITED BY LAW, IN NO EVENT WILL NVIDIA BE LIABLE FOR ANY DAMAGES, INCLUDING WITHOUT LIMITATION ANY DIRECT, INDIRECT, SPECIAL, INCIDENTAL, PUNITIVE, OR CONSEQUENTIAL DAMAGES, HOWEVER CAUSED AND REGARDLESS OF THE THEORY OF LIABILITY, ARISING OUT OF ANY USE OF THIS DOCUMENT, EVEN IF NVIDIA HAS BEEN ADVISED OF THE POSSIBILITY OF SUCH DAMAGES. Notwithstanding any damages that customer might incur for any reason whatsoever, NVIDIA's aggregate and cumulative liability towards customer for the products described herein shall be limited in accordance with the Terms of Sale for the product.

Trademarks

NVIDIA, the NVIDIA logo, and Mellanox are trademarks and/or registered trademarks of NVIDIA Corporation and/or Mellanox Technologies Ltd. in the U.S. and in other countries. Other company and product names may be trademarks



of the respective companies with which they are associated.

Copyright

© 2022 NVIDIA Corporation & affiliates. All Rights Reserved.

